

XGT  
40V<sup>LI-ION</sup>  
max

Makita®



PROMOFOLDER

01/10/2022 - 31/03/2023

## NIEUWIGHEDEN

Artikel	Pagina
HR009GZ02	8
HR009GM202	8
GA041GZ	12
GA041GM201	12
GA044GZ	12
GA044GM201	12
GA047GZ	12
GA047GM201	12
CS002GZ	13
PT001GZ01	14
PT001GD101	14
RT001GZ16	15
RT001GM208	15
VR001GZ	21
VR003GZ	21
VR003GM101	21
VR004GZ	21
VR004GM101	21
CW003GZ	23
DHR400GZUN	32
DJR189ZJ	37
DMC300RTJ	45
DTR181ZJ	48
DMR056	58
MR009GZ	58
DEAML005G	60-61
DEAML009G	60-61
CL117FDX2	71
CL117FDX5	71
CL117FDX8	71
DCL280FZW	71
CL003GZ04	71
CL003GD202	71
VC008GZ	73
VC009GZ01	75
DRC300Z	75
GA7082	87
GA7070YX1	87
GA9082	87
GA9070YX1	87
GA9071YX1	87
RP1111CJ	92
RP1802F	92
DUC307ZX2	G13 / 109
DUC307RTX2	G13 / 109
DUC357ZX2	G13 / 109
DUC357RTX2	G13 / 109

## COMBOPACKS

Artikel	Pagina
Combopacks XGT	18-19
Combopacks LXT	51-53
Combopacks CXT	69
Combopacks slijpers	51,88
Combopacks zaagmachines	38,93
Combopacks tuin	G20 / 102
Combopacks cleaning	70

## PROMOTIES

Artikel	Promotie	Pagina
DF001GZ01	B-28606	6
HP001GZ01	B-28606	6
TD001GZ02	E-03567	7
TD001GD201	E-03567	7
TD001GM201	E-03567	7
DK0114G201	MR001GZ	18
DK0125G301	TW004GZ	18
DK0126G401	191J65-4	19
DK0128G601	191J97-1	19
DHR243RTJ	BL1850B	30
DTW700RTJ	DCM501Z	33
DHS680RTJ	BL1850B	38
DLS111ZU	B-67290	39
DLS211ZU	B-67315	39
DTM52RTJX1	LD030P	43
Pallet 199137-9	DTR180ZJ	48
DLX2418TJ	E-13568	52-53
DLX1036TJ1	DMR116	52-53
DLX1108TJ1	DMR116	52-53
DF333DNX10	DEAML103	63
CLX228SAX2	DEAML103	69
DCL182Z	199491-1	71
DCL280FZ	191D71-3	71
DCL280FZW	191D71-3	71
DVC863LZ	CL102DW	76
HR4013C	HR2470FTP	79
HR4511C	HR2470FTP	79
HR5212C	HR2470FTP	79
HM0871C	E-04927	80
HM1812	D-54972	81
LS1019L	DEBWST06	95
LS1219L	DEBWST06	95
SKR200Z	P-81315	99
SK105DZ	BL1021B + DC10SB	100-101
SK105GDZ	BL1021B + DC10SB	100-101
SK106DZ	BL1021B + DC10SB	100-101
SK106GDZ	BL1021B + DC10SB	100-101
SK10GDZ	197658-5	100-101
SK20GDZ	197658-5	100-101
SK40GDZ	197658-5	100-101
SK209GDZ	197658-5	100-101
SK312GDZ	197658-5	100-101
SK700DZ	197658-5	100-101
SK700GDZ	197658-5	100-101
DCU180Z	199009-8 + 197624-2	G16 / 106

### MAKITA WERKT VOLGENS DE RICHTLIJNEN VAN DE EPTA



EPTA staat voor European Power Tool Association en is een vereniging van de belangrijkste fabrikanten van powertools. De EPTA stelt verplichte richtlijnen op, waardoor uniforme en vergelijkbare specificaties en gegevens gegarandeerd worden. Zo zijn er richtlijnen voor het gewicht (zonder snoer maar met alle machine toebehoren die voor het normale gebruik noodzakelijk zijn), voor slagkracht, enz.

In het verleden had iedere fabrikant zijn eigen norm, daarom waren de gegevens voor de invoering van EPTA, van fabrikant tot fabrikant verschillend en niet met elkaar vergelijkbaar.

Om u zo correct mogelijk te informeren, meet Makita uitsluitend volgens de richtlijnen van de EPTA. In al onze media (catalogi, folders, website, enz.) worden daarom enkel waarden conform de EPTA-richtlijnen gebruikt.



Accu gereedschap

6



Stofzuigers

76



Boor- en breekhamers

78



Boormachines

82



Bevestiging

83



Metaal

84



Slijpers

85



Beton

89



Hout

91



Pneumatisch gereedschap

98



Lasers

99



Tuingereedschap

102

**XGT**

# 40V **Li-ion** max



## Next Generation Technology

XGT is een nieuw platform met specifieke machines, accu's en laders. De combinatie van Makita's bewezen motortechnologie, geavanceerde elektronische sturing en kwalitatieve 40Vmax-batterijen biedt een geweldig alternatief voor de meest veeleisende gebruiker. Het platform vult het bestaande CXT- en LXT-platform aan en is de volgende, logische stap naar een snoerloze toekomst.

## Digitale communicatie

Op het XGT-platform kunnen de machines en accu's nu ook onderling digitaal communiceren via geïntegreerde elektronica. Dat resulteert in een perfect energiemangement, optimale prestaties en bovendien een effectieve bescherming van alle componenten bij extreme belasting.

## Optimaal laden

Digitaal geoptimaliseerd laadtraject met twee ventilatoren voor een perfecte temperatuurcontrole en continue actieve bijsturing van het laadtraject. Het resultaat zijn nog snellere laadtijden en een langere levensduur van de batterijen.



# De nieuwste innovatie in accugereedschap



**KRACHTIG**



**TOEKOMST-GERICHT**



**INTELLIGENT**



**BETROUW-BAAR**

- |   |   |  |   |   |
|---|---|--|---|---|
| <p><b>191L29-0</b><br/>Li-ion accu BL4020<br/>40Vmax • 2,0 Ah • 0,69 kg • 22 min*</p> | <p><b>191B36-3</b><br/>Li-ion accu BL4025<br/>40Vmax • 2,5 Ah • 0,71 kg • 28 min*</p> | <p><b>191B26-6</b><br/>Li-ion accu BL4040<br/>40Vmax • 4,0 Ah • 1 kg • 45 min*</p> | <p><b>191L47-8</b><br/>Li-ion accu BL4050F<br/>40Vmax • 5,0 Ah • 1,3 kg • 50 min*</p> | <p><b>191X65-8</b><br/>Li-ion accu BL4080F<br/>40Vmax • 8,0 Ah • 2,0 kg • 80 min*</p> |
|---|---|--|---|---|



- |   |   |   |   |   |
|---|---|---|---|---|
| <p><b>191V07-0</b><br/>XGT Powerpack 2,0 Ah</p> | <p><b>191J81-6</b><br/>XGT Powerpack 2,5 Ah</p> | <p><b>191J65-4</b><br/>XGT Powerpack 4,0 Ah</p> | <p><b>191J97-1</b><br/>XGT Powerpack 4,0 Ah</p> | <p><b>191V35-5</b><br/>XGT Powerpack 5,0 Ah</p> |
|---|---|---|---|---|



- |   |   |   |   |  |
|---|---|---|---|--|
| <p><b>191U00-8</b><br/>XGT Powerpack 4,0 Ah</p> | <p><b>191U28-6</b><br/>XGT Powerpack 4,0 Ah</p> | <p><b>191U13-9</b><br/>XGT Powerpack 5,0 Ah</p> | <p><b>191U42-2</b><br/>XGT Powerpack 5,0 Ah</p> | <p><b>191Y97-1</b><br/>XGT Powerpack 8,0 Ah<br/>2 x BL4080F + DC40RB in makpac</p> |
|---|---|---|---|--|



- 191E07-8**  
**Oplader DC40RA**  
Snellader voor XGT 40Vmax accu's



- 191N09-8**  
**Duo snellader DC40RB**  
Duo snellader voor het gelijktijdig laden van twee XGT 40Vmax accu's



- 191C10-7**  
**ADP10 Laadadapter**  
Adapter om LXT 14,4 V en 18 V accu's te laden op een XGT 40Vmax lader



- DEAADP001G**  
**ADP001 Laadadapter**  
USB-adapter voor XGT 40Vmax accu's



\* Laadtijd met DC40RA

## HP001 / DF001

- Maximaal koppel tot 140 Nm
- Tot 35 % hogere snelheid
- Bestand tegen continu werken onder hoge belasting

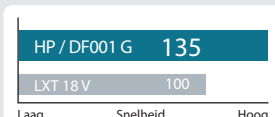

**Tot 35 % hogere rotatiesnelheid en meer koppel**  
Maakt het mogelijk om meer werk te verrichten op kortere tijd.



**41 elektronische koppelinstellingen**  
Voor een groter instelbereik en grotere nauwkeurigheid.



**Uiterst compact**  
In vergelijking met de LXT-variant 24 mm korter.



**Active Feedback sensing Technology**  
Schakelt de machine uit bij een plotsse zwenkbeweging.



HP001GM201



DF002GD201



DF001GZ01 & HP001GZ01 :  
gratis 37-delige schroefbitset B-28606

	DF002GZ01	DF002GD201	DF001GZ01	DF001GM201	HP002GZ01	HP002GD201	HP001GZ01	HP001GM201
Spanning	36 V (40Vmax)	36 V (40Vmax)	36 V (40Vmax)	36 V (40Vmax)	36 V (40Vmax)	36 V (40Vmax)	36 V (40Vmax)	36 V (40Vmax)
Max. koppel zacht / hard	30 / 64 Nm	30 / 64 Nm	68 / 140 Nm	68 / 140 Nm	30 / 64 Nm	30 / 64 Nm	68 / 140 Nm	68 / 140 Nm
Boorkop	1,5 - 13 mm	1,5 - 13 mm	1,5 - 13 mm	1,5 - 13 mm	1,5 - 13 mm	1,5 - 13 mm	1,5 - 13 mm	1,5 - 13 mm
Klopboorfunctie	-	-	-	-	✓	✓	✓	✓
Bijgeleverde accu's	0	2 x BL4025	0	2 x BL4040	0	2 x BL4025	0	2 x BL4040
Lader	-	DC40RA	-	DC40RA	-	DC40RA	-	DC40RA
Gewicht	2,5 kg	2,5 kg	2,7 kg	2,7 kg	2,6 kg	2,6 kg	2,7 kg	2,7 kg
Prijs in €	excl. btw							
	incl. btw							

## Ezychange T.C.T. gatzagen

- ✓ Ezychange snelwisselsysteem: één adapter voor alle diameters!
- ✓ Drie zijdelingse gaten zorgen voor een efficiënte verwijdering van zaagafval.
- ✓ Wolframcarbide tanden (T.C.T.): extreem hard, lange levensduur, hoge snijnsnelheid!

ARTIKEL	DIAMETERS (MM)	Nuttige lengte (mm)	Prijs incl btw
E-14261	22, 25, 32, 44, 51, 68	60	



**Ezychange**  
TCT

**Ezychange**  
TCT

## Ezychange BIM gatzagen

- ✓ Ezychange snelwisselsysteem: één adapter voor alle diameters
- ✓ Variabele vertanding voor snelle zaagsnedes
- ✓ HSS-bimetaal met 8% kobalt voor een hoge duurzaamheid

ARTIKEL	DIAMETERS (MM)	Nuttige lengte (mm)	Prijs incl btw
E-12310	16, 20, 25, 32, 40, 51	44	
E-12304	19, 22, 29, 38, 44, 57	44	
E-12326	20, 25, 32, 40, 51, 65	44	
E-12295	25, 32, 40, 51, 65, 68, 76	44	



**Ezychange**  
Bi-Metal HSS 8%Co

### ACCU SLAGSCHROEVENDRAAIERS



Maximaal koppel  
**220**  
Nm

Promo: gratis 11-delige schroef-bitset IMPACT PREMIER



**10 hulpfuncties**  
4 niveaus voor snelheid/  
kracht, en 6 functies voor  
specifieke toepassingen.



TD001GD201

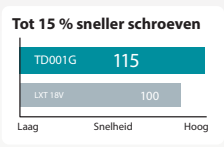

	TD001GZ02	TD001GD201	TD001GM201
--	-----------	------------	------------

Spanning	36 V (40Vmax)	36 V (40Vmax)	36 V (40Vmax)
Bitopname	1/4 " hex	1/4 " hex	1/4 " hex
Max. koppel	220 Nm	220 Nm	220 Nm
Slagkrachtniveaus	4	4	4
Hulpfuncties	6	6	6
Bijgeleverde accu's	0	2 x BL4025	2 x BL4040
Lader	-	DC40RA	DC40RA
Gewicht	1,7 kg	1,7 kg	1,7 kg
Prijs in €	excl. btw		
	incl. btw		

ACCU HAAKSE BOORMACHINE



DA001GM101

- Zeer hoog koppel (136 Nm)
- Twee mechanische snelheden
- Ingebouwde mechanische slipkoppeling

	DA001GZ01	DA001GM101
Spanning	36 V (40Vmax)	36 V (40Vmax)
Toerental	0 - 400 t.p.m. 0 - 1500 t.p.m.	0 - 400 t.p.m. 0 - 1500 t.p.m.
Hard koppel	70/136 Nm	70/136 Nm
Boorkop	13 mm	13 mm
Bijgeleverde accu's	-	1 x BL4040
Bijgeleverde lader	-	DC40RA
Gewicht	5,3 - 6,2 kg	5,3 - 6,2 kg
Prijs in €	excl. btw	
	incl. btw	

ACCU COMBIHAMERS SDS-PLUS



HR007GM201



HR002GM202



HR009GZ02

NIEUW

NIEUW

	HR007GZ01	HR007GM201	HR002GZ02	HR002GZ05	HR002GM202	HR002GM204	HR009GZ02	HR009GM202
Spanning	36 V (40Vmax)	36 V (40Vmax)	36 V (40Vmax)	36 V (40Vmax)	36 V (40Vmax)	36 V (40Vmax)	36 V (40Vmax)	36 V (40Vmax)
Slagenergie	3,0 J	3,0 J	2,9 J	2,9 J	2,9 J	2,9 J	3,9 J	3,9 J
Max. Ø beton	28 mm	28 mm	28 mm	28 mm	28 mm	28 mm	30 mm	30 mm
Trillingsniveau (ah)	7,5 m/s <sup>2</sup>	7,5 m/s <sup>2</sup>	6,0 m/s <sup>2</sup>	6,0 m/s <sup>2</sup>	6,0 m/s <sup>2</sup>	6,0 m/s <sup>2</sup>	9,1 m/s <sup>2</sup>	9,1 m/s <sup>2</sup>
Stofafzuigingsunit	DX15: optioneel	DX15: optioneel	DX14: optioneel	DX14: inbegrepen	DX14: optioneel	DX14: inbegrepen	DX11: inbegrepen	DX11: inbegrepen
AWS	✓ (excl. Bluetooth unit)	✓ (excl. Bluetooth unit)	✓	✓	✓	✓	✓ (excl. Bluetooth unit)	✓ (excl. Bluetooth unit)
Bijgeleverde accu's	-	2 x BL4040	-	-	2 x BL4040	2 x BL4040	-	2 x BL4040
Lader	-	DC40RA	-	-	DC40RA	DC40RA	-	DC40RA
Gewicht	5,0 kg	5,0 kg	4,1 kg	5,7 kg	4,1 kg	5,7 kg	5,2 - 6,8 kg	5,2 - 6,8 kg
Prijs in €	excl. btw							
	incl. btw							

**AFT** Active feedback sensing technology

Deze technologie schakelt de motor onmiddellijk uit bij het plots blokkeren van de machine. De HR002G, HR007G en HR009G maken daarbij gebruik van een accelerometer die de zwenkbeweging van de machine detecteert. De AFT-technologie verhoogt de veiligheid enorm.



# NEXT GENERATION TECHNOLOGY

ACCU COMBIHAMERS SDS-MAX

BL  
MOTOR

XGT  
40V  
Li-Ion  
max

XGT X2  
80Vmax



## HR005G

- Uitstekende vermogen/gewichtsverhouding
- Beveiliging tegen terugslag (AFT met accelerometer)
- Actieve trillingsdemping (AVT)

Slagenergie  
**8,0 J**



HR005GM20

## HR006G

- 2 x 40Vmax accu's in serie zorgen voor extreme kracht
- Beveiliging tegen terugslag (AFT met accelerometer)
- Actieve trillingsdemping (AVT)

Slagenergie  
**20,0 J**



HR006GZ



	HR005GZ01	HR005GM20	HR006GZ
Spanning	36 V (40 Vmax)	36 V (40 Vmax)	2 x 36 V (40 Vmax)
AWS	✓	✓	✓ (excl. Bluetooth unit)
Trillingsniveau (ah)	5 m/s <sup>2</sup>	5 m/s <sup>2</sup>	8,5 m/s <sup>2</sup>
Capaciteit beton	40 mm	40 mm	52 mm
Slagenergie	8,0 J	8,0 J	20,0 J
Toerental onbelast	250 - 500 min <sup>-1</sup>	250 - 500 min <sup>-1</sup>	250 - 310 min <sup>-1</sup>
Slagfrequentie	1450 - 2900 min <sup>-1</sup>	1450 - 2900 min <sup>-1</sup>	1100 - 2250 min <sup>-1</sup>
Bijgeleverde Accu's	-	2 x BL4040	-
Gewicht	7,4 kg - 8,2 kg	7,4 kg - 8,2 kg	12,9 - 14,3 kg
Prijs in €	excl. btw		
	incl. btw		

## HM001G



- Evenaart de kracht van modellen op netstroom
- Hoge slagenergie (9,4 J)
- Uitzonderlijk laag trillingsniveau dankzij actieve trillingsdemping (AVT) en een anti-vibratie behuizing



HM001GM205

## HM002G



- Extreem krachtig dankzij twee 40Vmax accu's in serie
- Zeer hoge slagenergie (20 J)
- Uitzonderlijk laag trillingsniveau dankzij actieve trillingsdemping (AVT) en een anti-vibratie behuizing



HM002GZ03

	HM001GZ04	HM001GM205	HM002GZ03
Spanning	36 V (40Vmax)	36 V (40Vmax)	2 x 36 V (40Vmax)
Slagenergie	9,4 J	9,4 J	20 J
Slagfrequentie	0 - 2650 min <sup>-1</sup>	0 - 2650 min <sup>-1</sup>	950 - 1900 min <sup>-1</sup>
Triax. vibratie beitelen (ah)	6,0 m/s <sup>2</sup>	6,0 m/s <sup>2</sup>	8,0 m/s <sup>2</sup>
AWS	✓	✓	✓ excl. Bluetooth unit
Bijgeleverde accu's	-	2 x BL4040	-
Bijgeleverde lader	-	DC40RA	-
Gewicht	6,3 - 7,1 kg	6,3 - 7,1 kg	12,0 - 13,3 kg
Prijs in €	excl. btw		
	incl. btw		

# NEXT GENERATION TECHNOLOGY

ACCU SLAGMOERSLEUTELS

**BL MOTOR** **XGT** **40V** **Li-ion** **max**



3 hulpfuncties voor het automatisch stoppen van de rotatie, zowel bij het vastdraaien als het losdraaien.



TW004GD201



TW007GD201



TW001GM201



Robuust slagmechanisme



BL-motor



Uiterst compact



## HULPFUNCTIES VOOR HET VASTDRAAIEN EN LOSDRAAIEN VAN BOUTEN

	Rechtsom (vastdraaien)	Linksom (losdraaien)
Boutfunctie	Deze functie helpt om continu schroeven erin te draaien met hetzelfde aandraaimoment. Deze functie helpt ook de kans te verkleinen dat de bouten/ moeren breken als gevolg van te strak vastdraaien.	Deze functie helpt voorkomen dat een bout eraf valt. Bij het losdraaien van een bout, zal het gereedschap automatisch stoppen of langzamer gaan draaien zodra de bout/moer voldoende los zit.
<b>mode 1</b>	Het gereedschap stopt automatisch zodra de slagwerking is begonnen.	Het gereedschap stopt automatisch zodra de slagwerking is gestopt.
<b>mode 2</b>	Het gereedschap stopt automatisch ongeveer 0,5 seconde na het moment waarop de slagwerking is begonnen.	Het gereedschap stopt automatisch ongeveer 0,2 seconde na het moment waarop de slagwerking is gestopt.
<b>mode 3</b>	Het gereedschap stopt automatisch ongeveer 1 seconde na het moment waarop de slagwerking is begonnen.	Het gereedschap gaat langzamer draaien nadat de slagwerking is gestopt.

	TW004GZ	TW004GD201	TW007GZ01	TW007GD201	TW007GM201	TW001GZ01	TW001GM201
Spanning	36 V (40Vmax)	36 V (40Vmax)	36 V (40Vmax)	36 V (40Vmax)	36 V (40Vmax)	36 V (40Vmax)	36 V (40Vmax)
Toerental	0-3200 tpm	0-3200 tpm	600-2300 tpm	600-2300 tpm	600-2300 tpm	0-1800 tpm	
Max. koppel	350 Nm	350 Nm	760 Nm	760 Nm	760 Nm	1800 Nm	1800 Nm
Dopaaansluiting	1/2"	1/2"	1/2"	1/2"	1/2"	3/4"	3/4"
Bijgeleverde accu's	0	2 x BL4025	0	2x BL4025	2x BL4040	0	2 x BL4040
Bijgeleverde lader	-	DC40RA	-	DC40RA	DC40RA	-	DC40RA
Verpakking	-	<b>MAK PAC</b>	<b>MAK PAC</b>	<b>MAK PAC</b>	<b>MAK PAC</b>	<b>MAK PAC</b>	<b>MAK PAC</b>
Gewicht	2,2 kg	2,2 kg	2,7 - 3,3 kg	2,7 - 3,3 kg	2,7 - 3,3 kg	3,9 kg	3,9 kg
Prijs in €	excl. btw						
	incl. btw						

ACCU HAAKSE SLIJERS 125 MM



Tot 40 % sneller doorslijpen

GA005G	140
LXT 18 V	100
Laag	hoog

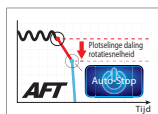

**Active Feedback sensing Technology**  
Schakelt de motor uit bij het plots blokkeren van de schijf

**Duurzaam**

- De BL-motor is verankerd met een zwaar uitgevoerde kogellager.
- Nieuw ontworpen schakelaar die zeer goed bestand is tegen slijtage.

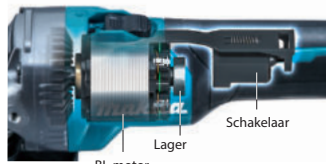

STOFAFZUIGING VOOR SLIJERS



191F81-2



191G06-2

**Gereedschapsloze beschermkap**

- Er is geen gereedschap nodig om de kap te monteren of te verwijderen.
- De beschermkap kan via een kliksysteem in de gewenste stand geplaatst worden.

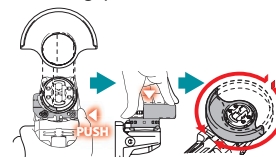

GA023GM201

	GA013GZ01	GA013GM201	GA005GZ01	GA005GM201	GA023GZ	GA023GM201	GA029GZ	GA029GM201
Spanning	36 V (40Vmax)	36 V (40Vmax)	36 V (40Vmax)	36 V (40Vmax)	36 V (40Vmax)	36 V (40Vmax)	36 V (40Vmax)	36 V (40Vmax)
Toerental onbelast	8500 t.p.m.	8500 t.p.m.	8500 t.p.m.	8500 t.p.m.	3000 - 8500 t.p.m.	3000 - 8500 t.p.m.	3000 - 8500 t.p.m.	3000 - 8500 t.p.m.
Regelbaar toerental	-	-	-	-	✓	✓	✓	✓
Type schakelaar	Lepelschakelaar	Lepelschakelaar	Schuifschakelaar	Schuifschakelaar	Schuifschakelaar	Schuifschakelaar	Lepelschakelaar	Lepelschakelaar
Dodemansschakelaar	✓	✓	-	-	-	-	✓	✓
AWS	-	-	-	-	✓	✓	✓	✓
Bijgeleverde accu's	0	2 x BL4040	0	2 x BL4040	0	2 x BL4040	0	2 x BL4040
Bijgeleverde lader	-	DC40RA	-	DC40RA	-	DC40RA	-	DC40RA
Gewicht	3,0 kg	3,0 kg	3,0 kg	3,0 kg	3,0 kg	3,0 kg	3,0 kg	3,0 kg
Verpakking	Makpac	Makpac	Makpac	Makpac	-	Makpac	-	Makpac
Prijs in €	excl. btw							
	incl. btw							

ACCU HAAKSE SLIJERS 125 MM X-LOCK



**XLOCK**

Snel en veilig schijven bevestigen via een kliksysteem.



GA044GM201



191G05-4 STOFAFZUIGKAP X-LOCK

STOFAFZUIGING VOOR SLIJERS



191F81-2

	GA041GZ	GA041GM201	GA044GZ	GA044GM201	GA047GZ	GA047GM201
Spanning	36 V (40Vmax)	36 V (40Vmax)	36 V (40Vmax)	36 V (40Vmax)	36 V (40Vmax)	36 V (40Vmax)
Schijfdiameter	125 mm	125 mm	125 mm	125 mm	125 mm	125 mm
Toerental onbelast	3,000 - 8,500 min <sup>-1</sup>	3,000 - 8,500 min <sup>-1</sup>	3,000 - 8,500 min <sup>-1</sup>	3,000 - 8,500 min <sup>-1</sup>	8,500 min <sup>-1</sup>	8,500 min <sup>-1</sup>
Slijpdiepte	31 mm	31 mm	31 mm	31 mm	31 mm	31 mm
Type schakelaar	Schuifschakelaar	Schuifschakelaar	Lepelschakelaar	Lepelschakelaar	Lepelschakelaar	Lepelschakelaar
AWS	✓	✓	✓	✓	-	-
Bijgeleverde accu's	-	2x BL4040	-	2x BL4040	-	2x BL4040
Bijgeleverde lader	-	DC40RA	-	DC40RA	-	DC40RA
Gewicht	3.0 - 5.3 kg	3.0 - 5.3 kg	3.0 - 5.3 kg	3.0 - 5.3 kg	3.0 - 5.3 kg	3.0 - 5.3 kg
Verpakking	-	Makpac	-	Makpac	-	Makpac
Prijs in €	excl. btw					
	incl. btw					

# NEXT GENERATION TECHNOLOGY

## ACCU DOORSLIJPER 355 MM

**BL**  
MOTOR

**XGT X2**  
80V<sub>max</sub>



- Uiterst krachtig dankzij 2x 40V<sub>max</sub> technologie
- Met soft start, AFT en elektrische rem
- Geïntegreerde watertoevoer
- XPT en Wetguard (IPX4) bescherming
- De combinatie van AVT technologie en een trillingsabsorberende behuizing zorgen voor een zeer laag vibratieniveau.

**CE001GZ**

Spanning	72 V (80V <sub>max</sub> )
Ø zaagblad	355 mm
Toerental onbelast	5300 min <sup>-1</sup>
Max. zaagdiepte	127 mm
Trillingsniveau (ah) vooraan / achteraan	2,5 m/s <sup>2</sup> / 1,8 m/s <sup>2</sup>
Bijgeleverde accu's/lader	-
Gewicht	12,3 - 14,1 kg
Prijs in €	excl. btw
	incl. btw

## ACCU METAALCIRKELZAAG 185 MM

**BL**  
MOTOR

**XGT**  
**40V**  
Li-ION  
**max**



CS002GZ

- Grote snijcapaciteit dankzij de compacte tandwieloverbrenging
- Compartiment in aluminium voor het opvangen van metaalsnippers
- De AFT functie schakelt de motor onmiddellijk uit wanneer het zaagblad blokkeert

**NIEUW**

**CS002GZ**

Spanning	36 V (40V <sub>max</sub> )
Ø zaagblad	185 mm
Toerental onbelast	3500 min <sup>-1</sup>
Max. zaagdiepte	67 mm
Trillingsniveau (ah)	2,5 m/s <sup>2</sup>
Bijgeleverde accu's/lader	-
Gewicht	4,2 - 5,4 kg
Prijs in €	excl. btw
	incl. btw

## ACCU HAAKSE SLIJPER 150 MM / 180 MM / 230 MM

**BL**  
MOTOR

**AWS**  
Auto-start Wireless System

**XGT**  
**40V**  
Li-ION  
**max**



Compacte afmetingen en kleine omtrek van de handgreep



GA038GM201



	GA035GZ	GA036GZ	GA037GZ01	GA037GM201	GA037GT201	GA038GZ01	GA038GM201	GA038GT201
Spanning	36 V (40V <sub>max</sub> )	36 V (40V <sub>max</sub> )	36 V (40V <sub>max</sub> )	36 V (40V <sub>max</sub> )	36 V (40V <sub>max</sub> )	36 V (40V <sub>max</sub> )	36 V (40V <sub>max</sub> )	36 V (40V <sub>max</sub> )
Schijfdiameter	150 mm	150 mm	180 mm	180 mm	180 mm	230 mm	230 mm	230 mm
Toerental onbelast	8500 min <sup>-1</sup>	8500 min <sup>-1</sup>	7800 min <sup>-1</sup>	7800 min <sup>-1</sup>	7800 min <sup>-1</sup>	6600 min <sup>-1</sup>	6600 min <sup>-1</sup>	6600 min <sup>-1</sup>
Slijpdiepte	46 mm	46 mm	68 mm	68 mm	68 mm	73 mm	73 mm	73 mm
Type schakelaar	Schuifschakelaar	Lepelschakelaar	Lepelschakelaar zonder vergrendeling	Lepelschakelaar zonder vergrendeling	Lepelschakelaar zonder vergrendeling	Lepelschakelaar zonder vergrendeling	Lepelschakelaar zonder vergrendeling	Lepelschakelaar zonder vergrendeling
AWS	-	-	✓ excl. Bluetooth unit	✓ excl. Bluetooth unit	✓ excl. Bluetooth unit	✓ excl. Bluetooth unit	✓ excl. Bluetooth unit	✓ excl. Bluetooth unit
Bijgeleverde accu's	-	-	-	2 x BL4040	2 x BL4050F	-	2 x BL4040	2 x BL4050F
Bijgeleverde lader	-	-	-	DC40RA	2 x BL1850B	-	DC40RA	DC40RA
Gewicht	3,0 - 3,7 kg	3,0 - 3,7 kg	4,4 - 5,4 kg	4,4 - 5,4 kg	4,4 - 5,4 kg	4,6 - 7,4 kg	4,6 - 7,4 kg	4,6 - 7,4 kg
Verpakking	-	-	coffret	coffret	coffret	coffret	coffret	coffret
Prijs in €	excl. btw							
	incl. btw							

## ACCU BANDZAGEN

**BL MOTOR** XGT **40V Li-ion max**



PB002GM201

- Grote zaagcapaciteit tot Ø127 mm
- Variabele snelheidsregeling
- Hoge bandsnelheid
- Gemakkelijke spoorverstelling

	PB002GZ	PB002GM201
Spanning	36 V (40Vmax)	36 V (40Vmax)
Zaagcapaciteit	127 x 127 mm	127 x 127 mm
Zaaglint	1140 x 13 x 0,5 mm	1140 x 13 x 0,5 mm
Bijgeleverde accu's	-	2x BL4040
Bijgeleverde lader	-	DC40RA
Gewicht	6,6 - 7,8 kg	6,6 - 7,8 kg
Prijs in €	excl. btw	
	incl. btw	

## ACCU SCHUUR- EN POETSMACHINE

**BL MOTOR** XGT **40V Li-ion max**



PV001GM101



	PV001GZ	PV001GM101
Spanning	36 V (40Vmax)	36 V (40Vmax)
Diameter	180 mm	180 mm
Toerental onbelast	0 - 2200 min <sup>-1</sup>	0 - 2200 min <sup>-1</sup>
Bijgeleverde accu's	-	1x BL4040
Bijgeleverde lader	-	DC40RA
Gewicht	3,2 - 3,9 kg	3,2 - 3,9 kg
Prijs in €	excl. btw	
	incl. btw	

## ACCU MINIBRADPISTOOL 18 GA

**BL MOTOR** XGT **40V Li-ion max**



FN00GA202

	FN001GZ02	FN001GA202
Spanning	36 V (40Vmax)	36 V (40Vmax)
Lengte nagels	15 - 40 mm	15 - 40 mm
Capaciteit magazijn	100	100
Bijgeleverde accu's	-	2x BL4020
Bijgeleverde lader	-	DC40RA
Gewicht	2,6 - 3,2 kg	2,6 - 3,2 kg
Makpac	✓	✓
Prijs in €	excl. btw	
	incl. btw	

## ACCU PINTACKER 23 GA

**BL MOTOR** XGT **40V Li-ion max**



PT001GD101

- Werkt sneller dankzij BL motor en herontworpen indrijvingsveer
- Mechanisme met bewegend tegengewicht voor lage terugslag

	PT001GZ01	PT001GD101
Spanning	36 V (40Vmax)	36 V (40Vmax)
Lengte nagels	15 - 35 mm	15 - 35 mm
Capaciteit magazijn	120	120
Bijgeleverde accu's	-	1x BL4025
Bijgeleverde lader	-	DC40RA
Gewicht	2,4 - 3,0 kg	2,4 - 3,0 kg
Makpac	✓	✓
Prijs in €	excl. btw	
	incl. btw	

## ACCU RECIPROZAGEN

**BL MOTOR** XGT **40V Li-ion max**

- Vermogen vergelijkbaar met model op netstroom
- Met pendelmechanisme (JR002G)
- Zeer laag trillingsniveau dankzij AVT technologie
- Handige bladontgrendelingshendel en verstelbare aanslag
- Ledverlichting



JR001GD201



JR002GM201

	JR001GZ	JR001GD201	JR001GM201	JR002GZ	JR002GM201
Spanning	36 V (40Vmax)	36 V (40Vmax)	36 V (40Vmax)	36 V (40Vmax)	36 V (40Vmax)
Slaglengte	32 mm	32 mm	32 mm	32 mm	32 mm
Aantal zaagbewegingen	0 - 2300 min <sup>-1</sup> 0 - 3000 min <sup>-1</sup>	0 - 2300 min <sup>-1</sup> 0 - 3000 min <sup>-1</sup>	0 - 2300 min <sup>-1</sup> 0 - 3000 min <sup>-1</sup>	0 - 3000 min <sup>-1</sup> 0 - 3000 min <sup>-1</sup>	0 - 3000 min <sup>-1</sup> 0 - 3000 min <sup>-1</sup>
Pendelinstelling	-	-	-	✓	✓
AVT	-	-	-	✓	✓
Bijgeleverde accu's	0	2 x BL4025	2 x BL4040	-	2 x BL4040
Bijgeleverde lader	-	DC40RA	DC40RA	-	DC40RA
Gewicht	4,2 kg	4,2 kg	4,2 kg	4,6 kg	4,6 kg
Prijs in €	excl. btw				
	incl. btw				



JR002G

# NEXT GENERATION TECHNOLOGY

## ACCU SCHAAF



- Even krachtig als een machine op netstroom
- Kan tot 4,0 mm in één passage schaven
- Spaanders kunnen links of rechts uitgeworpen worden
- Zool met 3 groeven voor het afschuiven van kanten
- Sponningsdiepte tot 25 mm



KP001GM20

	KP001GZ01	KP001GM202
Spanning	36 V (40Vmax)	36 V (40Vmax)
Toerental onbelast	15000 min <sup>-1</sup>	15000 min <sup>-1</sup>
Schaafbreedte	82 mm	82 mm
Max. spaanafname	40mm	40mm
AWS	✓	✓
Bijgeleverde accu's	-	2x BL4040
Bijgeleverde lader	-	DC40RA
Gewicht	3,7 - 4,9 kg	3,7 - 4,9 kg
Prijs in €	excl. btw	
	incl. btw	

## ACCU INVALCIRKELZAAG



SP001GZ03



**AWS compatibel**  
Voor het draadloos aansturen van een AWS compatibele stofzuiger. (incl. Bluetooth unit)

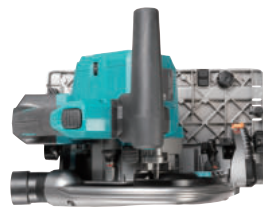

**Compact en licht, perfect uitgebalanceerd.**  
Door het gebruik van slechts één 40Vmax accu en magnesium componenten.



**Grote zaagcapaciteit**  
Zaagdiepte van 56 mm bij 90° en een kantelbereik van -1 tot 48°.

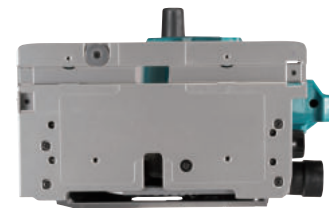

**Perfekte geleiding**  
De magnesium zool past rechtstreeks op een geleiderail.

SP001GZ03

	SP001GZ03	
Spanning	36 V (40Vmax)	
Ø zaagblad	165 mm	
Toerental onbelast	2500 - 4900 min <sup>-1</sup>	
Zaagdiepte (90°)	56 mm	
AWS	✓	
Bijgeleverde accu's	0	
Gewicht	4,4 - 5,0 kg	
Prijs in €	excl. btw	
	incl. btw	

## ACCU BOVEN- EN KANTENFREES



RT001GM208

- Compact en flexibel systeem
- Zeer hoog vermogen danzij 40Vmax technologie
- Zachte rem
- Verschillende hulpstukken meegeleverd



	NIEUW RT001GZ16	NIEUW RT001GM208
Spanning	36 V (40Vmax)	36 V (40Vmax)
Toerental onbelast	10000-31000 min <sup>-1</sup>	10000-31000 min <sup>-1</sup>
Max. induikdiepte	40 mm	40 mm
Ø spantang - bereik	6 - 8 mm	6 - 8 mm
Ø spantang - inbegrepen	6 mm, 8 mm	6 mm, 8 mm
AWS	✓	✓
Bijgeleverde accu's	-	2x BL4040
Bijgeleverde lader	-	DC40RA
Gewicht	2,2 - 2,5 kg	2,2 - 2,5 kg
Prijs in €	excl. btw	
	incl. btw	

Nieuwe grotere BL motor met hoog vermogen en laag gewicht  
Speciale constructie voor maximum zaagdiepte en groot kantelbereik  
HS009G: magnesium zool, compatibel met geleiderail  
HS010G: aluminium zool, niet compatibel met geleiderail  
HS011G: magnesium zool, compatibel met geleiderail



HS003GM201



HS009GT201



HS011GT201

	HS003GZ	HS003GM201	HS004GZ	HS004GZ01	HS004GM202	HS009GZ	HS009GT201	HS010GZ	HS010GT201	HS011GZ	HS011GT201
Spanning	36 V (40Vmax)	36 V (40Vmax)	36 V (40Vmax)	36 V (40Vmax)	36 V (40Vmax)	36 V (40Vmax)	36 V (40Vmax)	36 V (40Vmax)	36 V (40Vmax)	36 V (40Vmax)	36 V (40Vmax)
Ø zaagblad	190 mm	190 mm	190 mm	190 mm	190 mm	235 mm	235 mm	235 mm	235 mm	270 mm	270 mm
Zaagdiepte (90°)	68,5 mm	68,5 mm	62,5 mm	62,5 mm	62,5 mm	85 mm	85 mm	85 mm	85 mm	101 mm	101 mm
Rechtstreeks op geleiderail	-	-	✓	✓	✓	✓	✓	-	-	✓	✓
AWS	✓ excl. Bluetooth unit	✓ excl. Bluetooth unit	✓ excl. Bluetooth unit	✓	✓	✓ excl. Bluetooth unit	✓ excl. Bluetooth unit	✓ excl. Bluetooth unit	✓ excl. Bluetooth unit	✓ excl. Bluetooth unit	✓ excl. Bluetooth unit
Bijgeleverde accu's	0	2 x BL4040	0	0	2 x BL4040	-	2x BL4050F	-	2x BL4050F	-	2x BL4050F
Bijgeleverde lader	-	DC40RA	-	-	DC40RA	-	DC40RA	-	DC40RA	-	DC40RA
Gewicht	4,1 - 4,4 kg	4,1 - 4,4 kg	4,4 - 4,7 kg	4,4 - 4,7 kg	4,4 - 4,7 kg	5,1 - 5,7 kg	5,1 - 5,7 kg	6,0 - 6,4 kg	6,0 - 6,4 kg	5,5 - 6,7 kg	5,5 - 6,7 kg
Verpakking	-	Makpac	-	-	Makpac	-	Koffer	-	Koffer	-	Koffer
Prijs in €	excl. btw										
	incl. btw										

RS001GM101



RS002GT101



- Speciaal ontwerp met handgreep achteraan
- Krachtig en licht (magnesium zool)



	RS001GZ	RS001GM101	RS002GZ	RS002GT101
Spanning	36 V (40Vmax)	36 V (40Vmax)	36 V (40Vmax)	36 V (40Vmax)
Zaagdiepte (90°)	65 mm	65 mm	95 mm	95 mm
Ø zaagblad	185 mm	185 mm	260 mm	260 mm
AWS	-	-	✓ excl. Bluetooth unit	✓ excl. Bluetooth unit
Bijgeleverde accu's	0	1 x BL4040	0	1 x BL4050F
Toerental onbelast	6400 min <sup>-1</sup>	6400 min <sup>-1</sup>	4000 min <sup>-1</sup>	4000 min <sup>-1</sup>
Gewicht	5,0 - 5,6 kg	5,0 - 5,6 kg	5,7 - 6,3 kg	5,7 - 6,3 kg
Prijs in €	excl. btw			
	incl. btw			



# NEXT GENERATION TECHNOLOGY

ACCU TELESCOPISCHE AFKORT - VERSTEKZAGEN

**BL** MOTOR **XGT** **40V** Li-ion max

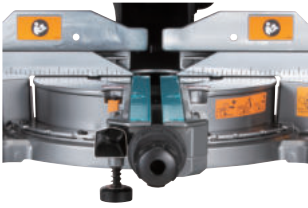

Belangrijke bedieningsknoppen zijn vooraan geplaatst

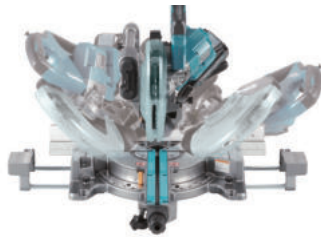

Verstek tot 60° en kantelhoek tot 48° in beide richtingen



Succesvol "rail-forward" ontwerp met stofafzuiging via twee poorten



LS002GZ01



Uitschuifbare zijsteunen



**Aanduiding van de zaaglijn**  
Een LED werpt een schaduw van het zaagblad op het werkstuk, deze aanduiding is onder alle omstandigheden exact.

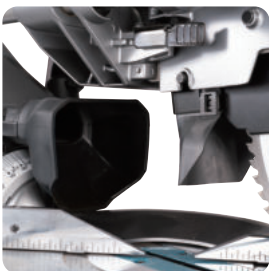

**Effectieve stofafzuiging**  
De geoptimaliseerde stofafzuiging met twee poorten garandeert een perfecte stofafzuiging, ook bij het zagen van dunne planken.



LS003GZ01

Kantelhoek 48° links en rechts

**DXT**  
Deep and Exact Cutting Technology

## DEEP CUTTING

De gepatenteerde constructie met drijvende tandwieloverbrenging en uitsparing achter de flens laat toe om een groter deel van het zaagblad te benutten. Daardoor kunnen ook hoge plinten verticaal of in verstek afgekort worden.



**Manuele bediening**  
De afzuiging kan via een schakelaar ook manueel gestart worden (via Bluetooth), dit is ook handig om de machine schoon te maken.

	LS002GZ01	LS004GZ01	LS003GZ01
Spanning	36 V (40Vmax)	36 V (40Vmax)	36 V (40Vmax)
Ø zaagblad	216 mm	260 mm	305 mm
Verstekhoek	60 L / 60 R	60° L / 60° R	60 L / 60 R
Kantelhoek	48° L / 48° R	48° L / 48° R	48° L / 48° R
Toerental onbelast	4800 min <sup>-1</sup>	3600 min <sup>-1</sup>	3600 min <sup>-1</sup>
Capaciteit	70 x 312 mm	91 x 312 mm	107 x 312 mm
AWS	✓	✓	✓
DXT	✓	✓	✓
Bijgeleverde accu's	0	0	0
Gewicht	16,4 - 17,0 kg	26,6 - 27,2 kg	30,5 - 31,1 kg
Prijs in €	excl. btw		
	incl. btw		

COMBOPACK XGT



Promo: Gratis  
MR001GZ  
t.w.v.

DK0114G201

Klopboor- en schroef- machine	HP001G
Slagschroevendraaier	TD001G
Bijgeleverde accu's	2 x BL4040
Lader	DC40RA
Laadadapter	ADP10
Verpakking	Gereedschapstas
Prijs in €	excl. btw incl. btw

COMBOPACK XGT



DK0124G201

Boor- en schroefmachine	DF001G
Haakse slijper 125 mm	GA005G
Bijgeleverde accu's	2 x BL4040
Lader	DC40RA
Verpakking	Makpac
Prijs in €	excl. btw incl. btw

COMBOPACK XGT



Promo: gratis  
TW004GZ  
t.w.v.

DK0125G301

Boor- en schroefmachine	DF001G
Slagschroevendraaier	TD001G
Haakse slijper 125 mm	GA005G
Bijgeleverde accu's	2 x BL4040
Lader	DC40RA
Verpakking	Makpac
Prijs in €	excl. btw incl. btw

# NEXT GENERATION TECHNOLOGY

COMBOPACK XGT

XGT  
40V Li-ion  
max



Promo: gratis  
Powerpack 4 Ah  
t.w.v.



DK0126G401

Boor- en schroefmachine	DF001G
Slagschroevendraaier	TD001G
Haakse slijper 125 mm	GA005G
Reciprozaag	JR001G
Bijgeleverde accu's	2 x BL4040
Lader	DC40RA
Verpakking	Gereedschapstas
Prijs in €	excl. btw
	incl. btw

COMBOPACK XGT

XGT  
40V Li-ion  
max



Promo: Gratis  
Powerpack 4 Ah  
t.w.v.



DK0128G601

Boor- en schroefmachine	DF001G
Slagschroevendraaier	TD001G
Haakse slijper 125 mm	GA005G
Reciprozaag	JR001G
SDS plus combihamer	HR002G
Cirkelzaag 190 mm	HS003G
Bijgeleverde accu's	2 x BL4040
Lader	DC40RA
Verpakking	Gereedschapstas
Prijs in €	excl. btw
	incl. btw

# HET XGT-PLATFORM



## DF001GZ01

Boor- en schroefma-  
chine 40Vmax



Makpac

## DF002GZ01

Boor- en schroefma-  
chine 40Vmax



Makpac

## HP001GZ01

Klopboor- en schroef-  
machine 40Vmax



Makpac

## HP002GZ01

Klopboor- en schroef-  
machine 40Vmax



Makpac

## DA001GZ01

Haakse boorma-  
chine 40Vmax



Koffer

## HR007GZ01

SDS+ Boorhamer  
40Vmax



Koffer

## HR002GZ05

SDS+ Boorhamer  
40Vmax



Makpac

## HR009GZ02

SDS+ Boorhamer  
40Vmax



Koffer

## HR005GZ01

SDS-Max Boorhamer  
40Vmax



Koffer

## HR006GZ

SDS-Max Breekha-  
mer 40Vmax



Koffer

## TD001GZ02

Slagschroeven-  
draaier 40Vmax



Makpac

## TW004GZ

Slagmoersleutel  
40Vmax



Karton

## TW007GZ01

Slagmoersleutel  
40Vmax



Makpac

## TW001GZ01

Slagmoersleutel  
40Vmax



Makpac

## JR001GZ

Reciprozaag 40Vmax



Karton

## JR002GZ

Reciprozaag 40Vmax



Karton

## GA013GZ01

Haakse slijper  
125 mm 40Vmax



Makpac

## GA029GZ

Haakse slijper  
125 mm 40Vmax



Karton

## GA041GZ

X-Lock haakse slijper  
125 mm 40Vmax



Karton

**NIEUW**

## GA044GZ

X-Lock haakse slijper  
125 mm 40Vmax



Karton

**NIEUW**

## GA038GZ01

Haakse slijper  
230 mm 40Vmax



Makpac

## CS002GZ

Metaalcirke-  
lzaag 40Vmax



Karton

## PB002GZ

Bandzaag 40Vmax



Karton

## HS003GZ

Cirkelzaag 190 mm  
40Vmax



Karton

## HS004GZ

Cirkelzaag 190 mm  
40Vmax



Karton

## HS009GZ

Cirkelzaag 190 mm  
40Vmax



Karton

## HS010GZ

Cirkelzaag  
230 mm 40Vmax



Karton

## HS011GZ

Cirkelzaag 270 mm  
40Vmax



Karton

## RS001GZ

Wormzaag 185 mm  
40Vmax



Karton

## RS002GZ

Wormzaag 260 mm  
40Vmax



Karton

## SP001GZ03

Invalcirkelzaag  
40Vmax



Makpac

## RT001GZ16

Boven- en kan-  
tenfrees 40Vmax



Makpac

**NIEUW**

## PT001GZ01

Afwerkingspistool  
40Vmax



Makpac

**NIEUW**

## FN001GZ02

Minibradpistool  
40Vmax



Makpac

## KP001GZ01

Schaaf 40Vmax



Makpac

## PV001GZ

Polijstmachine  
40Vmax



Karton

## VR001GZ

Betontrilnaald  
40Vmax



Karton

**NIEUW**

## VR003GZ

Betontrilnaald  
40Vmax



Karton

**NIEUW**

## VR004GZ

Betontrilnaald  
40Vmax



Karton

**NIEUW**

## CF002GZ

Ventilator 40Vmax



Karton

## CL001GZ05

Steelfstofzuiger  
40Vmax



Karton

## CL002GZ03

Steelfstofzuiger  
40Vmax



Karton

## CL002GZ07

Steelfstofzuiger  
40Vmax



Karton

## CL003GZ04

Steelfstofzuiger  
40Vmax



Karton

**NIEUW**

## VC003GLZ

Bedrijfsstofzuiger  
40Vmax



Karton

## VC002GLZ01

Bedrijfsstofzuiger  
40Vmax



Karton

## VC005GLZ

Bedrijfsstofzuiger  
40Vmax



Karton

## MP001GZ

Miniluchtpomp  
40Vmax



Karton

## AS001GZ

Blaas- en zuigma-  
chine 40Vmax



Karton

## KT001GZ

Waterkoker 40Vmax



Karton



1. CHOOSE YOUR BODY!
2. CHOOSE YOUR POWER!
3. MIX IT UP!



ACCU BETONTRILNAALDEN



VR001GZ



VR003G



## ACCESSOIRES

Artikel	Diameter	Lengte
1910E1-5	32 mm	1,2 m
1910E2-3	32 mm	1,7 m
1910C2-9	32 mm	2,4 m
1910E3-1	38 mm	1,2 m
1910C4-5	38 mm	2,4 m

	NIEUW	NIEUW	NIEUW	NIEUW	NIEUW
	VR001GZ	VR003GZ	VR003GM101	VR004GZ	VR004GM101
Spanning	36 v (40Vmax)	36 v (40Vmax)	36 v (40Vmax)	36 v (40Vmax)	36 v (40Vmax)
Ø trilflës	-(enkel motor)	32 mm	32 mm	38 mm	38 mm
Lengte naald	-(enkel motor)	1,2 m	1,2 m	1,2 m	1,2 m
Trillingsfrequentie	12000-15000 min <sup>-1</sup>	12000-15000 min <sup>-1</sup>	12000-15000 min <sup>-1</sup>	12000-15000 min <sup>-1</sup>	12000-15000 min <sup>-1</sup>
Bijgeleverde accu's	-	-	1x BL4040	-	1x BL4040
Bijgeleverde lader	-	-	DC40RA	-	DC40RA
Gewicht	4,8 - 7,8 kg	4,8 - 7,8 kg	4,8 - 7,8 kg	4,8 - 7,8 kg	4,8 - 7,8 kg
Prijs in €	excl. btw				
	incl. btw				

VR004G leverbaar vanaf november

MINILUCHTPOMP



Max. luchtdebiet:  
24 l/min  
Max. druk: 11,1 bar



- Door het hoge debiet kunnen grotere banden en bijvoorbeeld ook speelgoed voor op het water opgeblazen worden.
- Drie modi: hoog debiet, laag debiet en "ball" mode om op een veilige manier speelballen op te blazen.
- Functie voor het aflaten van lucht indien de druk te hoog is.



**Nauwkeurige instelling**  
Via het digitale bedieningspaneel kan de gewenste einddruk ingesteld worden.



**Lucht aflaten**  
Indien de druk te hoog is kan via een knopje op het toestel lucht afgelaten worden.

		MP001GZ
Spanning		36 V (40Vmax)
Debiet		12 – 24 l/min
Max. druk		11,1 bar
Bijgeleverde accu's		0
Gewicht		2,9 – 3,5 kg
Prijs in €	excl. btw	
	incl. btw	

BLAAS- EN ZUIGMACHINE



- 4 vermogenstanden en variabele snelheid
- Handig kliksysteem voor het verwisselen van mondstukken
- Kan ook lucht wegzuigen via een optioneel accessoire
- Standaard geleverd met 5 blaasmonden



• Standaard



• Optioneel



**Toepassingen:**

- Schoonblazen (gereedschap, machines, computers).
- Reinigen van luchtfilters
- Uitblazen van ankerгатen
- Opblazen/aflaten van strandballen, bootjes enz.
- Leegzuigen van verpakkingen (compacteer maken)



		AS001GZ
Spanning		36 V (40Vmax)
Blaaskracht		2,8 N
Debiet		0 - 1,3 m³/min
Max. onderdruk		103 mbar
Bijgeleverde accu(s)		-
Bijgeleverde lader		-
Gewicht		1,5 – 2,3 kg
Prijs in €	excl. btw	
	incl. btw	

WATERKOKER



- Voeding met één XGT accu of twee in parallel
- Dubbellaagse roestvrijstalen wand
- Met voedingsstandaard en groot handvat
- Uitgerust met morsbeveiliging

		KT001GZ
Spanning		36 V (40Vmax)
Inhoud		0,8 l
Kooktijd voor 0,8 l		ca. 8 min
Verwarmcapaciteit 100 °C		1,2 l met 2 x BL4025
Gewicht		2,8 - 5,9 kg
Prijs in €	excl. btw	
	incl. btw	

VRIES-/ KOELBOX MET VERWARMFUNCTIE



- Voeding via accu's of netstroom
- Hoog koelvermogen dankzij compressor
- 7 temperatuurinstellingen voor koelen en 7 voor verwarmen
- Uitgebreid statusdisplay



NIEUW

	CW003GZ	CW001GZ
Voeding	36 V (40Vmax) XGT / 18 V LXT / AC / 12 V DC - 24 V DC	36 V (40Vmax) XGT / 18 V LXT / AC / 12 V DC - 24 V DC
Inhoud	7 l	20 l
Koelstanden	-18 / -15 / -10 / -5 / 0 / 5 / 10 °C	-18 / -15 / -10 / -5 / 0 / 5 / 10 °C
Warm standen	30 / 35 / 40 / 45 / 50 / 55 / 60 °C	30 / 35 / 40 / 45 / 50 / 55 / 60 °C
Autonomie ca.	-18 °C: 5,5 uur, 5 °C: 13,5 uur, 60 °C: 5,5 uur (1x BL4040F)	-18 °C: 8 uur, 5 °C: 22,5 uur, 60 °C: 7 uur (2x BL4040)
Afmetingen	456 x 245 x 308 mm	663 x 341 x 372 mm
Gewicht	7,9 - 9,4 kg	13,8 - 16,1 kg
Prijs in €	excl. btw	
	incl. btw	

ACCU VENTILATOREN



AC adapter inbegrepen



- Voeding via accu of netstroom
- Met zwenkfunctie en timer
- Hoge luchtsnelheid en stille werkin
- Afneembare bescherming voor gemakkelijk reinigen



	CF001GZ	CF002GZ
Spanning	36 V (40Vmax) XGT / AC (Incl. AC-adapter)	36 V (40Vmax) XGT / AC (Incl. AC-adapter)
Diameter	235 mm	330 mm
Debiet (stand 1-2-3)	5,2 / 6,5 / 8,2 m <sup>3</sup> /min	10 / 15 / 21 m <sup>3</sup> /min
Luchtsnelheid	120 / 150 / 190 m/min	120 / 170 / 240 m/min
Gewicht	2,0 - 3,0 kg	4,5 - 5,1 kg
Prijs in €	excl. btw	
	incl. btw	

# Het grootste 18 V Lithium-ion assortiment ter wereld.

Meer dan 380 machines met slechts 1 accu.

**18V**  
**LITHIUM-ION**

**3**  
JAAR  
**GARANTIE**  
OP MACHINES  
Na registratie op  
[www.makita.be](http://www.makita.be)

**LXT**

Lithium-Ion Extreme Technology

- + Performante Lithium-Ion accu's
- + Een unieke en snelle oplaadtechnologie
- + Energie-efficiënte koolborstelloze motoren
- + Meervoudige bescherming tegen overbelasting







18V LITHIUM-ION

# LXT-Platform

Betrouwbaar – veelzijdig – krachtig

## Snel en optimaal laden

Wanneer de batterijen warm zijn, dan is het belangrijk dat die eerst gekoeld worden vooraleer het laadtraject te starten. De lader is uitgerust met een ventilator die de batterijen koelt vóór en tijdens het laden om de laadtijd te verkorten.

Makita geavanceerd laadsysteem  
Geforceerde koeling



Snelladen

Standaard laadsysteem  
Natuurlijke warmteafvoer



Langere laadtijd



## Digitale communicatie

De processor communiceert met de in de batterij ingebouwde chip om te laden bij de optimale spanning, stroom en temperatuur en om de levensduur van de batterij te optimaliseren.

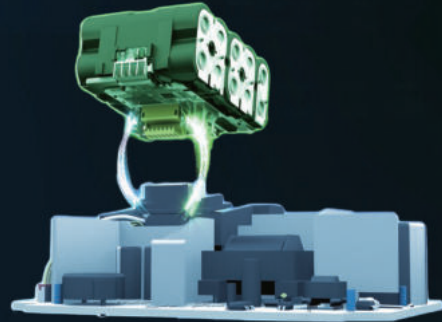

Geoptimaliseerd laadtraject

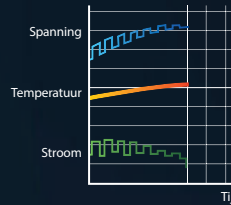

Standaard laadtraject

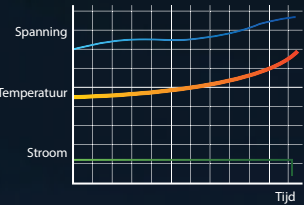

**3.0Ah**  
**Li-ion**

22 minuten

3,0 Ah  
BL1830B

SNELSTE LAADTIJD

**4.0Ah**  
**Li-ion**

36 minuten

4,0 Ah  
BL1840B

**5.0Ah**  
**Li-ion**

45 minuten

5,0 Ah  
BL1850B

**6.0Ah**  
**Li-ion**

55 minuten

6,0 Ah  
BL1860B

LANGSTE WERKDUUR



**DRAAGBAAR ACCUPACK**

**PDC01**

**PDC1200**

**191A59-5**

PDC01 ZONDER BATTERIJEN

Inclusief adapter  
18 V & 2 x 18 V



**191C50-5**

PDC01 MET 4 x BL1850B EN  
DUOSNELLADER DC18RD

PDC01 KAN TOT 4 LXT-  
BATTERIJEN DRAGEN



BL1850B

DC18RD

**BEAPDC1200A01**

DRAAGBAAR ACCUPACK PDC1200  
MET GEÏNTEGREERDE BATTERIJCELLEN

ENERGIECAPACITEIT  
1206 Wh



Inclusief lader 191L00-4  
(DC4001) en adapter  
191J51-5 (2 x 18 V)

**197280-8**

accu BL1850B 18V 5,0 Ah



**197288-2**

TWINPACK 18V 2 x 5,0 Ah



**197422-4**

accu BL1860B 18V 6,0 Ah



**DEBADP05**

USB-adapter

USB-adapter voor 14,4V/18V accu's



**197494-9**

POWERPACK 18V 2 x 4,0 Ah



**197624-2**

POWERPACK 18V 2 x 5,0 Ah



**197629-2**

POWERPACK 18V 2 x 5,0 Ah



**197626-8**

POWERPACK 18V 4 x 5,0 Ah



**198116-4**

Powerpack 18V 2 x 6,0 Ah



**198077-8**

POWERPACK 18V 2 x 6,0 Ah



**198091-4**

POWERPACK 18V 4 x 6,0 Ah



**198170-8**

accu timer LXT BPS01  
Programmeert de werkdur van  
14,4V & 18V accu's



**195584-2**

OPLADER DC18RC

Snellader voor LXT accu's van 14,4/18V



**196933-6**

DUBBELLADER DC18RD

Duo snellader voor LXT accu's: 14,4/18V



2 accu's BL1850 laden  
in 45 minuten

**198720-9**

OPLADER DC18RE

Snellader voor zowel CXT als LXT accu's



**LXT**

**CXT**

**196426-3**

Oplader DC18SF

Oplader met 4 poorten voor LXT accu's.  
Laadt twee accu's tegelijk op



(traaglader)

ACCU BOOR- EN SCHROEFMACHINE

**14.4V**  
LITHIUM-ION



incl. 59 accessoires

DDF343RYX2

		DDF343RYX2
Spanning		14,4V
Hard koppel		36 Nm
Boorkop		1-10 mm
Bijgeleverde accu's		2 x BL1415N
Gewicht		1,4 kg
Prijs in €	excl. btw	
	incl. btw	

ACCU (KLOP-)BOOR- EN SCHROEFMACHINE

**18V**  
LITHIUM-ION



DHP453RFX2

incl. 96 accessoires

DHP453RFX2

		DHP453RFX2
Spanning		18V
Hard koppel		42 Nm
Boorkop		1,5-13 mm
Bijgeleverde accu's		2 x BL1830B
Gewicht		1,7 kg
Prijs in €	excl. btw	
	incl. btw	

ACCU (KLOP-)BOOR- EN SCHROEFMACHINES

**MAK PAC**

**18V**  
LITHIUM-ION



DDF485RT3J



DDF484RT3J



DDF486RT3J

DDF453RF3J    DDF482RT3J    DDF485RT3J    DDF484RT3J    DDF486RT3J    DHP486RT3J

Spanning		18V	18V	18V	18V	18V	18V
BL-motor		-	-	✓	✓	✓	✓
Klopboorfunctie		-	-	-	-	-	✓
Hard koppel		42 Nm	62 Nm	50 Nm	54 Nm	130 Nm	130 Nm
Boorkop		1,5-13 mm	1,5-13 mm	1,5-13 mm	1,5-13 mm	1,5 - 13 mm	1,5 - 13 mm
Bijgeleverde accu's		3 x BL1830B	3 x BL1850B	3 x BL1850B	3 x BL1850B	3 x BL1850B	3 x BL1850B
Gewicht		1,7 kg	1,7 kg	1,5 kg	1,5 kg	2,3 - 2,6 kg	2,3 - 2,7 kg
Prijs in €	excl. btw						
	incl. btw						

**PROMO**

3e Accu

ACCU (KLOP-)BOOR- EN SCHROEFMACHINES



Wilst je dat er van DDF484 en DHP486 ook de voordelige uitvoeringen DDF484Z / DDF484T1J en DHP486Z / DHP486T1J bestaan? Zie p. 52 - 53 voor meer info!



	DDF083ZJ	DDF487RAJ	DDF485RTJ	DDF484RTJ	DDF486RTJ	DHP487RAJ	DHP485RFJ	DHP484RTJ	DHP486RTJ
Spanning	18 V	18 V	18 V	18 V	18 V	18 V	18 V	18 V	18 V
Klopboorfunctie	-	-	-	-	-	✓	✓	✓	✓
Hard koppel	40 Nm	40 Nm	50 Nm	54 Nm	130 Nm	40 Nm	50 Nm	54 Nm	130 Nm
Opname	1/4 hex	1,5 - 13 mm	1,5-13 mm	1,5-13 mm	1,5-13 mm	1,5 - 13 mm	1,5-13 mm	1,5-13 mm	1,5 - 13 mm
Bijgeleverde accu's	-	2 x BL1820	2 x BL1850B	2 x BL1850B	2 x BL1850B	2 x BL1820	2 x BL1830B	2 x BL1850B	2 x BL1850B
Gewicht	1,1 - 1,4 kg	1,3 - 1,6 kg	1,4 kg	1,5 kg	1,3 kg	1,3 - 1,6 kg	1,4 kg	1,6 kg	2,3 - 2,7 kg
Prijs in €	excl. btw								
	incl. btw								

ACCU HAAKSE BOORMACHINES



	DDA350RTJ	DDA351RTJ	DDA450RTE	DDA460ZK
Spanning	18 V	18 V	18 V	2 x 18 V
Toerental	0-1800 t.p.m.	0-1800 t.p.m.	0 - 450 t.p.m. 0 - 1400 t.p.m.	0-350 t.p.m. 0-1400 t.p.m.
BL motor	-	-	✓	✓
XPT	-	-	✓	✓
Hard koppel	13,7 Nm	13,7 Nm	26/70 Nm	70/136 Nm
Boorkop	1,5-10 mm	1,5-10 mm	1,5-13 mm	1,5-13 mm
Bijgeleverde accu's	2 x BL1850B	2 x BL1850B	2 x BL1850B	-
Gewicht	1,8 kg	1,8 kg	3,2 kg	5,7 kg
Prijs in €	excl. btw			
	incl. btw			

ACCU BIKHAMER SDS-PLUS



DHK180RTJ



		DHK180ZJ	DHK180RTJ
Spanning		18V	18V
Bijgeleverde accu's		0	2 x BL1850B
Slagenergie		3,1 J	3,1 J
Slagfrequentie		0 - 3200/min	0 - 3200/min
Triaxiale vibratiewaarde (ah)		4,5 m/s <sup>2</sup>	4,5 m/s <sup>2</sup>
Gewicht		3,3 kg	3,3 kg
Prijs in €	excl. btw		
	incl. btw		

ACCU BOORHAMERS SDS-PLUS



DHR171RTJ

**PROMO**

Gratis 3e BL1850B bij DHR243RTJ



DHR202RTJ



DHR243RTJW

DHR182RTWJ  
DHR243RTJW  
inclusief STOF AFZUIGING



DHR182RTWJ

		DHR171RTJ	DHR202RTJ	DHR182RTJ	DHR182RTWJ	DHR243RTJ	DHR243RTJW
Spanning		18V	18V	18V	18V	18V	18V
Slagenergie		1,2 J	2 J	1,7 J	1,7 J	2 J	2 J
Max. Ø beton		16 mm	20 mm	18 mm	18 mm	24 mm	24 mm
BL-motor		✓	-	✓	✓	✓	✓
AVT		-	-	✓	✓	-	-
AWS		-	-	✓	✓	-	-
				excl. Bluetooth unit	excl. Bluetooth unit		
Stofafzuigstelsysteem		-	-	-	DX05	-	DX07
Bijgeleverde accu's		2 x BL1850B	2 x BL1850B	2 x BL1850B	2 x BL1850B	2 x BL1850B	2 x BL1850B
Gewicht		2,1 kg	3,5 kg	2,4 kg	3,3 kg	3,2 kg	4,7 kg
Prijs in €	excl. btw						
	incl. btw						

Wist je dat er van DHR243 ook de voordelige uitvoeringen DHR243Z en DHR243T1J bestaan? Zie p. 52-53 voor meer info!

# Technologie

## AFT

### Active feedback sensing technology

Deze technologie schakelt de motor onmiddellijk uit bij het plots blokkeren van de machine. Sommige machines zoals de DHR283 maken daarbij gebruik van een accelerometer die de zwenkbeweging van de machine detecteert. De AFT-technologie verhoogt de veiligheid enorm.

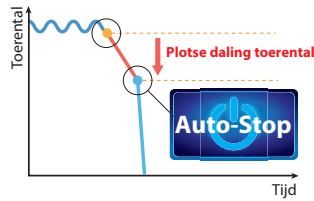

## AVT

### Anti-vibration technology

Het AVT-systeem reduceert trillingen drastisch door het gebruik van een systeem met bewegend tegengewicht, hetgeen het gebruikscomfort sterk verbetert.

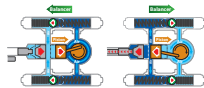

### Auto-start wireless system

Dankzij AWS wordt de stofafzuiging bij accu-toestellen automatisch geactiveerd d.m.v. een Bluetooth®-verbinding.



## ACCU COMBIHAMERS SDS-PLUS



DHR283G2JU



DHR264PT2J

Alle modellen **INCLUSIEF** extra automatische boorkop



**AWS**  
**AVT**  
**AFT**

DHR283ZWJU & DHR283GX1  
inclusief  
STOFAFZUIGING



	DHR264PT2J	DHR283ZJU	DHR283ZWJU	DHR283G2JU
Spanning	2 x 18V	2 x 18V	2x18V	2 x 18V
BL-motor	-	✓	✓	✓
Slagenergie	2,5 J	2,8 J	2,8 J	2,8 J
Max. Ø beton	26 mm	28 mm	28 mm	28 mm
Bijgeleverde accu's	2 x BL1850B	0	0	2 x BL1860B
AWS	-	✓	✓	✓
AVT	-	✓	✓	✓
AFT	-	✓	✓	✓
Stofafzuigstelsysteem	-	-	DX09	-
Gewicht	4,2 kg	4,0 kg	5,5 kg	4,0 kg
Prijs in €	excl. btw			
	incl. btw			



# PREMIUM BEITELSET SDS-PLUS EN SDS-MAX

- ✓ 2 keer langere levensduur dan de standaard beitels!
- ✓ Zeer efficiënt: vormvast. Het afbraakwerk is veel productiever!

## 3-DELIGE PREMIUM BEITELSET SDS-PLUS

### SDS-PLUS

E-04911



1 puntbeitel 250 mm  
1 koudbeitel 20 x 250 mm  
1 platte beitel 40 x 250 mm



#### AntiJam™ ontwerp

Verhoogt de productiviteit  
Vermindert de wrijving en de kans op blokkeren  
Speciaal ontworpen voor SDS-PLUS machines



## 5-DELIGE PREMIUM BEITELSET SDS-MAX

### SDS-MAX

E-04927



2 puntbeitels 400 mm  
2 koudbeitels 25 x 400 mm  
1 platte beitel 50 x 380 mm



#### BreakPower™ ontwerp

Verhoogt de productiviteit  
Vermindert de wrijving en de kans op blokkeren  
Speciaal ontworpen voor SDS-MAX machines

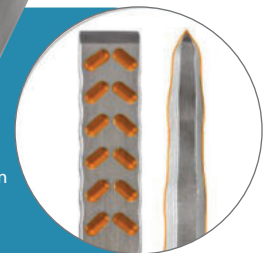

## ACCU COMBIHAMER SDS-MAX

**BL MOTOR AVT**

**AWS** 18V+18V → 36V



DHR400ZKU1  
incl. stofafzuiging 199142-6

**NIEUW**

DHR400ZKU DHR400ZKUN DHR400ZKU1 DHR400G2UN

Spanning	2 x 18V	2 x 18V	2 x 18V	2 x 18V
Slagenergie	8 J	8 J	8 J	8 J
Max. Ø beton	40 mm	40 mm	40 mm	40 mm
Vibratieniveau hamerboren	5,0 m/s <sup>2</sup>	5,0 m/s <sup>2</sup>	5,0 m/s <sup>2</sup>	5,0 m/s <sup>2</sup>
AWS	✓	✓	✓	✓
AFT	-	✓	-	✓
Bijgeleverde accu's	-	-	-	2 x BL1860B
Gewicht	8,1 kg	8,1 kg	8,1 kg	8,1 kg
Prijs in €	excl. btw			
	incl. btw			

## ACCU HETELUCHTPISTOLEN

**MAX PAC 18V LITHIUM-ION**



DHG180RT1J

DHG181RT1J

- Snelle wissel van het mondstuk
- Veilige schakelaar, te blokkeren in uit en aan stand
- Verschillende mondstukken zijn inbegrepen

	DHG180RT1J	DHG181RT1J
Spanning	18V	18V
Temperatuurbereik	550 °C	6 standen, max 550 °C
Debiet	200 l/min	120 l/min, 200 l/min
Bijgeleverde accu's	1x BL1850B	1x BL1850B
Gewicht	1,0 - 1,3 kg	1,0 - 1,4 kg
Prijs in €	excl. btw	
	incl. btw	



ACCU SLAGMOERSLEUTELS



**Auto-stop functie:**  
de machine stopt automatisch van zodra de bout of moer voldoende is losgedraaid

**PROMO**

Gratis koffiezet-apparaat DCM501Z bij DTW700RTJ

Wist je dat er van DTW300 de voordelige uitvoeringen DTW300Z en DTW300TJ bestaan? Zie p. 52-53 voor meer uitleg!



DTW1001RTJ



DTW190RTJ



DTW300RTJ



DTW700RTJ



DTW181RTJ

	DTW181RTJ	DTW190RTJ	DTW300RTJ	DTW700RTJ	DTW1001RTJ	DTW1002RTJ
Spanning	18V	18V	18V	18V	18V	18V
BL-motor	✓	-	✓	✓	✓	✓
XPT	✓	-	✓	✓	-	-
Toerental	0-2400 tpm.	0-2400 tpm.	0-3200 tpm.	0-2200 tpm.	0-1800 t.p.m.	0-1800 t.p.m.
Max. koppel	180 Nm	190 Nm	330 Nm	700 Nm	1050 Nm	1000 Nm
Dopaansluiting	1/2" vierkant	1/2" vierkant	1/2" vierkant	1/2" vierkant	3/4" vierkant	1/2" vierkant
Auto-stop functie	✓	-	✓	✓	-	-
Bijgeleverde accu's	2 x BL1850B	2 x BL1850B	2 x BL1850B	2 x BL1850B	2 x BL1850B	2 x BL1850B
Gewicht	1,2 kg	1,4 kg	1,8 kg	2,6 kg	3,4 kg	3,3 kg
Prijs in €	excl. btw					
	incl. btw					

ACCU RATELMOERSLEUTEL



Geleverd met 1/4" & 3/8" opname

Verwijderbare kop laat toe om 13 mm moeren over de lengte van een M8 draadstang te schroeven.



DWR180ZJ

	DWR180ZJ	DWR180RA1J
Spanning	18V	18V
Toerental onbelast	0-800 t.p.m.	0-800 t.p.m.
Max. koppel	47,5 Nm	47,5 Nm
Bijgeleverde accu's	0	1 x BL1820B
Gewicht	1,2 kg	1,2 kg
Prijs in €	excl. btw	
	incl. btw	



# Impact PREMIER

## ACCESSOIRES

# IMPACT PREMIER

**Duurzamer door de dubbele torsie!**



**E-13568**  
5-delige schroefbitset



**Past zeer nauwkeurig in de schroef.**

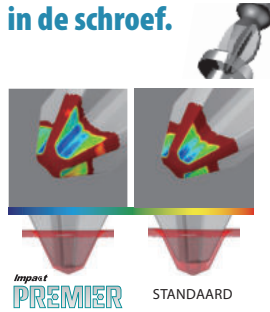

**E-03567**  
11-delige schroefbitset



**Gebruik van hoogwaardig staal. Ondersteunt een hoog koppel.**

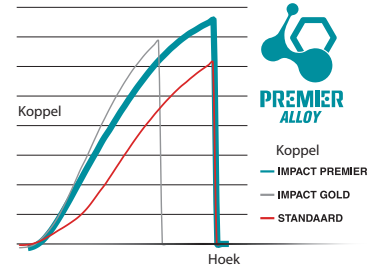

**E-13552**  
31-delige schroefbitset

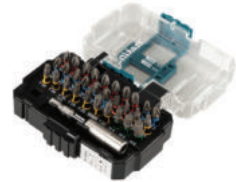

- E-03121 Schroefbit IMPACT PREMIER PH1-25 mm, 2 stks
- E-03137 Schroefbit IMPACT PREMIER PH2-25 mm, 2 stks
- E-03143 Schroefbit IMPACT PREMIER PH2(slim)-25 mm, 2 stks
- E-03159 Schroefbit IMPACT PREMIER PH3-25 mm, 2 stks
- E-03165 Schroefbit IMPACT PREMIER PZ1-25 mm, 2 stks
- E-03171 Schroefbit IMPACT PREMIER PZ2-25 mm, 2 stks
- E-03187 Schroefbit IMPACT PREMIER PZ3-25 mm, 2 stks
- E-03193 Schroefbit IMPACT PREMIER T10-25 mm, 2 stks
- E-03202 Schroefbit IMPACT PREMIER T15-25 mm, 2 stks
- E-03218 Schroefbit IMPACT PREMIER T20-25 mm, 2 stks
- E-03224 Schroefbit IMPACT PREMIER T25-25 mm, 2 stks
- E-03230 Schroefbit IMPACT PREMIER T30-25 mm, 2 stks
- E-03246 Schroefbit IMPACT PREMIER PH2-25 mm, 15 stks Flip top
- E-03252 Schroefbit IMPACT PREMIER PZ2-25 mm, 15 stks Flip top

- E-03268 Schroefbit IMPACT PREMIER PH1-50 mm, 2 stks
- E-03274 Schroefbit IMPACT PREMIER PH2-50 mm, 2 stks
- E-03280 Schroefbit IMPACT PREMIER PH3-50 mm, 2 stks
- E-03296 Schroefbit IMPACT PREMIER PZ1-50 mm, 2 stks
- E-03305 Schroefbit IMPACT PREMIER PZ2-50 mm, 2 stks
- E-03311 Schroefbit IMPACT PREMIER PZ3-50 mm, 2 stks
- E-03327 Schroefbit IMPACT PREMIER T10-50 mm, 2 stks
- E-03333 Schroefbit IMPACT PREMIER T15-50 mm, 2 stks
- E-03349 Schroefbit IMPACT PREMIER T20-50 mm, 2 stks
- E-03355 Schroefbit IMPACT PREMIER T25-50 mm, 2 stks
- E-03361 Schroefbit IMPACT PREMIER T30-50 mm, 2 stks
- E-03377 Schroefbit IMPACT PREMIER PH2-50 mm, 10 stks Flip top
- E-03383 Schroefbit IMPACT PREMIER PZ2-50 mm, 10 stks Flip top

- E-06286 Dubbelbit IMPACT PREMIER PH2-65 mm, 2 stks
- E-06292 Dubbelbit IMPACT PREMIER PZ2-65 mm, 2 stks
- E-03399 IMPACT PREMIER Torsion bithouder 68 mm
- E-03408 IMPACT PREMIER Torsion bithouder 150 mm
- E-03414 ULTRA MAG bithouder IMPACT PREMIER TORSION
- E-03420 IMPACT PREMIER Tilt adapter 1/4" voor krachtdoppen 3/8" - 50 mm
- E-03436 IMPACT PREMIER Tilt adapter 1/4" voor krachtdoppen 1/2" - 50 mm
- E-03442 IMPACT PREMIER Mag Boost magneet voor schroefbits
- E-03458 IMPACT PREMIER Torsion dopsleutel H6-65 mm
- E-03464 IMPACT PREMIER Torsion dopsleutel H8-65 mm
- E-03470 IMPACT PREMIER Torsion dopsleutel H10-65 mm
- E-03486 IMPACT PREMIER Torsion dopsleutel H13-65 mm
- E-03492 IMPACT PREMIER krachtdop H13-80 mm
- E-03501 IMPACT PREMIER krachtdop H15-80 mm
- E-03517 IMPACT PREMIER krachtdop H17-80 mm
- E-03523 IMPACT PREMIER krachtdop H19-80 mm
- E-03539 IMPACT PREMIER krachtdop H21-80 mm
- E-03567 11-delige IMPACT PREMIER schroefbitset
- E-03573 11-delige IMPACT PREMIER schroefbitset
- E-12027 Schroefbit IMPACT PREMIER T40-50 mm
- E-13568 5-delige IMPACT PREMIER schroefbitset
- E-13552 31-delige IMPACT PREMIER schroefbitset



ACCU HAAKSE  
SLAGSCHROEVENDRAAIER

18V  
LITHIUM-ION



MAK  
PAC

DTL061RTJ

Spanning	18 V
Toerental	0-2000 t.p.m.
Bijgeleverde accu's	2 x BL1850B
Gewicht	1,8 kg
Prijs in €	excl. btw
	incl. btw

ACCU SLAGSCHROEVENDRAAIERS

XPT

MAK  
PAC

18V  
LITHIUM-ION

Assist mode: voor het vlot aanzetten bij het schroeven.

T-modus: instelling voor zelftappende schroeven.



DTD157RTJ



DTD153RTJ



DTD172RTJ

Wist je dat er van DTD153 de voordelige uitvoeringen DTD153Z en DTD153TJ bestaan? Zie p. 52-53 voor meer info!

	DTD156RTJ	DTD157RTJ	DTD153RTJ	DTD154RTJ	DTD172RTJ
Spanning	18 V	18 V	18 V	18 V	18 V
BL-motor	-	✓	✓	✓	✓
Toerental	0-2500 t.p.m.	0-3000 t.p.m.	0-3400 t.p.m.	0-3600 t.p.m.	0-3600 t.p.m.
Max. koppel	155 Nm	140 Nm	170 Nm	175 Nm	180 Nm
Bitopname	1/4" hex.	1/4" hex.	1/4" hex.	1/4" hex.	1/4" hex.
Bijgeleverde accu's	2 x BL1850B	2 x BL1850B	2 x BL1850B	2 x BL1850B	2 x BL1850B
Slagkrachtniveaus	-	2	-	3	4
T-modus	-	-	-	✓	✓
Assist mode	-	✓	-	-	✓
Gewicht	1,3 kg	1,2 kg	1,5 kg	1,5 kg	1,5 kg
Prijs in €	excl. btw				
	incl. btw				

ACCU HYBRIDE  
BOOR- EN SCHROEFMACHINE

BL  
MOTOR

MAK  
PAC

18V  
LITHIUM-ION



4 modi: klopboren, boren schroeven, slagschroeven

DTP141RTJ

DTP141ZJ DTP141RTJ

Spanning	18 V	18 V
Toerental	0-2700 t.p.m.	0-2700 t.p.m.
Bijgeleverde accu's	-	2 x BL1850B
Gewicht	1,8 kg	1,8 kg
Prijs in €	excl. btw	
	incl. btw	

ACCU HYDRAULISCHE  
SLAGSCHROEVENDRAAIERS

MAK  
PAC

18V  
LITHIUM-ION



DTS141ZJ

Uiterst stil dankzij het unieke hydraulische impulssysteem

DTS141ZJ

Spanning	18 V
Toerental	0-3200 t.p.m.
Max. koppel	40 Nm
Bitopname	1/4" hex
T-modus	✓
Bijgeleverde accu's	-
Gewicht	1,5 kg
Prijs in €	excl. btw
	incl. btw

ACCU AFWERKINGSPISTOOL  
23 Ga



DPT353RTJ

Spanning	18V
Doorsnede nagel	0,6 mm
Lengte nagel	15-35 mm
Bijgeleverde accu's	2 x BL1850B
Gewicht	2,0 kg
Prijs in €	excl. btw
	incl. btw

ACCU NIETMACHINES



DST221RTJ

DST221:  
Aluminium magazijn

DST112RTJ DST221RTJ

Spanning	18V	18V
Rugbreedte niet	10 mm	10,5 mm
Lengte niet	7-10 mm	10-22 mm
Bijgeleverde accu's	2 x BL1850B	2 x BL1850B
Gewicht	1,5 kg	2,1 kg
Prijs in €	excl. btw	
	incl. btw	

ACCU MINIBRADPISTOLEN  
18 Ga



DFN350RTJ



DBN500RTJ

DFN350RTJ DBN500RTJ

Spanning	18V	18V
Doorsnede nagel	1,2 mm	1,2 mm
XPT	✓	-
Lengte nagel	15-35 mm	15-50 mm
Bijgeleverde accu's	2 x BL1850B	2 x BL1850B
Gewicht	2,1 kg	3,2 kg
Prijs in €	excl. btw	
	incl. btw	

Voor zacht hout

ACCU BRADPISTOOL  
16 Ga



DBN600RTJ

Voor zacht hout

Spanning	18V
Doorsnede nagel	1,6 mm
Lengte nagel	25-64 mm
Bijgeleverde accu's	2 x BL1850B
Gewicht	3,4 kg
Prijs in €	excl. btw
	incl. btw

ACCU LAMELLENFREES



DPJ180RTJ

Spanning	18V
Toerental	6500 t.p.m.
Bijgeleverde accu's	2 x BL1850B
Gewicht	3,2 kg
Prijs in €	excl. btw
	incl. btw

ACCU SCHAAF



DKP181RTJU



DKP181RTJU

Spanning	18V
Toerental	12000 t.p.m.
Schaafbreedte	82 mm
Max. spaanafname	3 mm
Sponningdiepte	25 mm
AWS	✓
Bijgeleverde accu's	2 x BL1850B
Gewicht	3,3 kg
Prijs in €	excl. btw
	incl. btw

ACCU RECIPROZAGEN

XPT

18V + 18V

36V

18V LITHIUM-ION



DJR360PT2



DJR187RTE



DJR189ZJ



DJR188RTJ

NIEUW

DJR189ZJ

- Kan met één hand gebruikt worden
- Uitstekend geschikt voor het zagen in nauwe ruimten en in de hoogte
- Uitermate licht en toch zeer krachtig
- Trillingsarm (systeem met bewegend tegengewicht)

	DJR189ZJ	DJR183RTJ	DJR186RTE	DJR188RTJ	DJR187RTE	DJR360PT2
Spanning	18 V	18 V	18 V	18 V	18 V	2 x 18 V
BL-motor	✓	-	-	✓	✓	✓
Toerental	0-3100 /min	0-3300 /min	0-2800 /min	0-3000 /min	0-3000 /min	0-3000 /min
Max. capaciteit hout	255 mm	50 mm	255 mm	255 mm	255 mm	255 mm
Bijgeleverde accu's	-	2 x BL1850B	2 x BL1850B	2 x BL1850B	2 x BL1850B	2 x BL1850B
Bijgeleverde lader	-	DC18RC	DC18RC	DC18RC	DC18RC	DC18RD
Gewicht	2,2 - 2,5 kg	1,6 kg	3,5 kg	2,9 kg	3,4 kg	4,6 kg
Prijs in €	excl. btw					
	incl. btw					

ACCU DECOUPEERZAGEN

MAK PAC

18V LITHIUM-ION



DJV181RTJ



DJV184RTJ



DJV182RTJ

Wist je dat er van DJV181 en DJ182 de voordelige uitvoeringen DJV181Z / DJV181T1J en DJV182Z / DJV182T1J bestaan? Zie p. 52-53 voor meer info!

	DJV184RTJ	DJV181RTJ	DJV182RTJ
Spanning	18 V	18 V	18 V
BL motor	✓	✓	✓
Aantal zaagbewegingen	0-3000 min <sup>-1</sup>	800-3500 min <sup>-1</sup>	800-3500 min <sup>-1</sup>
Max. capaciteit hout	135 mm	135 mm	135 mm
Slaglengte	23 mm	26 mm	26 mm
Bijgeleverde accu's	2 x BL1850B	2 x BL1850B	2 x BL1850B
Gewicht	2,1 kg	2,5 kg	2,5 kg
Prijs in €	excl. btw		
	incl. btw		

ACCU INVALCIRKELZAGEN  
165 mm

18V → 18V → 36V

BL MOTOR MAK PAC

Geleiderail  
194368-5 bij PT2J1



DSP600PT2J1

DSP601ZJU DSP600PT2J DSP600PT2J1

	DSP601ZJU	DSP600PT2J	DSP600PT2J1
Spanning	2 x 18V	2 x 18V	2 x 18V
Zaagdiepte	56 mm	56 mm	56 mm
Diameter asgat	20 mm	20 mm	20 mm
AWS	✓	-	-
Bijgeleverde accu's	0	2 x BL1850B	2 x BL1850B
Aantal MAKPAC-koffers	1	2	2
Gewicht	4,4 kg	4,4 kg	4,4 kg
Prijs in €	excl. btw		
	incl. btw		

ACCU METAALCIRKELZAGEN

MAK PAC

18V LITHIUM-ION



DCS552RTJ



DCS553RTJ

DCS552RTJ DCS553RTJ

	DCS552RTJ	DCS553RTJ
Spanning	18V	18V
BL-motor	-	✓
Ø zaagblad	136 mm	150 mm
Zaagdiepte (90°)	50,5 mm	57,5 mm
Bijgeleverde accu's	2 x BL1850B	2 x BL1850B
Gewicht	2,4 kg	3,0 kg
Prijs in €	excl. btw	
	incl. btw	

COMBOPACK



DSP600

BL1850B



DJV182



DC18RD

DLX2234PX1

Invalcirkelzaag	DSP600
Decoupeerzaag	DJV182
Bijgeleverde accu's	2 x BL1850B
Lader	DC18RD
Prijs in €	excl. btw
	incl. btw

ACCU CIRKELZAGEN

MAK PAC

18V → 18V → 36V

18V LITHIUM-ION



DHS660RTJ



DHS782PT2J



DHS680RTJ



Promo DHS680RTJ:  
gratis 3e BL1850B

Wist je dat er van DHS680 de voordelige uitvoeringen DHS680Z en DHS680T1J bestaan? Zie p. 52-53 voor meer info!

DHS782, DHS783 & DHS900  
passen rechtstreeks op geleiderail

	DSS501RTJ	DHS680RTJ	DHS660RTJ	DHS661RTJU	DHS630RTJ	DHS710PT2J	DHS782PT2J	DHS783T2JU	DHS900PT2	DHS900PT2U
Spanning	18V	18V	18V	18V	18V	2 x 18V	2 x 18V	2 x 18V	2 x 18V	2 x 18V
BL-motor	✓	✓	✓	✓	-	-	✓	✓	✓	✓
Zaagdiepte (90°)	51 mm	57 mm	57 mm	57 mm	66 mm	68,5 mm	62,5 mm	62,5 mm	85 mm	85 mm
Ø zaagblad	136 mm	165 mm	165 mm	165 mm	165 mm	190 mm	190 mm	190 mm	235 mm	235 mm
AWS	-	-	-	✓	-	-	-	✓	✓	✓
Bijgeleverde accu's	2 x BL1850B	2 x BL1850B	2 x BL1850B	2 x BL1850B	2 x BL1850B	2 x BL1850B	2 x BL1850B	2 x BL1850B	2 x BL1850B	2 x BL1850B
Gewicht	2,7 kg	3,3 kg	3,4 kg	3,4 kg	3,5 kg	4,7 kg	4,5 kg	4,5 kg	5,3 kg	5,3 kg
Prijs in €	excl. btw									
	incl. btw									

ACCU AFKORT-VERSTEKZAAG



DLS600RTE

Spanning	18 V
Ø zaagblad	165 mm
Max. zaagcapaciteit bij 90°	46 x 92 mm
Bijgeleverde accu's	2 x BL1850B
Gewicht	6,6 kg
Prijs in €	excl. btw
	incl. btw

# EFFICUT

Fijner, sneller en efficiënter snijden



Scan mij voor meer info!



Meer zaagsneden per batterijlading



Snel zagen



Langere levensduur



Zuivere zaagsnede



ACCU TELESCOPISCHE AFKORT-VERSTEKZAGEN



## DXT

Deep and Exact Cutting Technology

De gepatenteerde constructie met drevoudige tandwieloverbrenging en uitsparing achter de flens laat toe om een groter deel van het zaagblad te benutten. Daardoor kunnen ook hoge plinten verticaal of in verstek afgekort worden.

**PROMO**  
 DLS111ZU :gratis Efficut zaagblad 80T (B-67290)  
 DLS211ZU: gratis Efficut zaagblad 80T (B-67315)



DLS714NPT2



DLS211ZU



	DLS714NPT2	DLS111ZU	DLS211ZU
Spanning	2 x 18 V	2 x 18 V	2 x 18 V
Ø Zaagblad	190 mm	260 mm	305 mm
Zaagdiepte (90°)	52 mm	91 mm	107 mm
Zaagbreedte (90°)	300 mm	310 mm	363 mm
DXT	-	✓	✓
AWS	-	✓	✓
Bijgeleverde accu's	2 x BL1850B	promo: B-67290	promo: B-67315
Gewicht	13,0 kg	27,3 kg	30,7 kg
Prijs in €	excl. btw		
	incl. btw		

ACCU MENGER



Ideaal voor het mengen van vloeistoffen, verf en lichte lijmsorten.

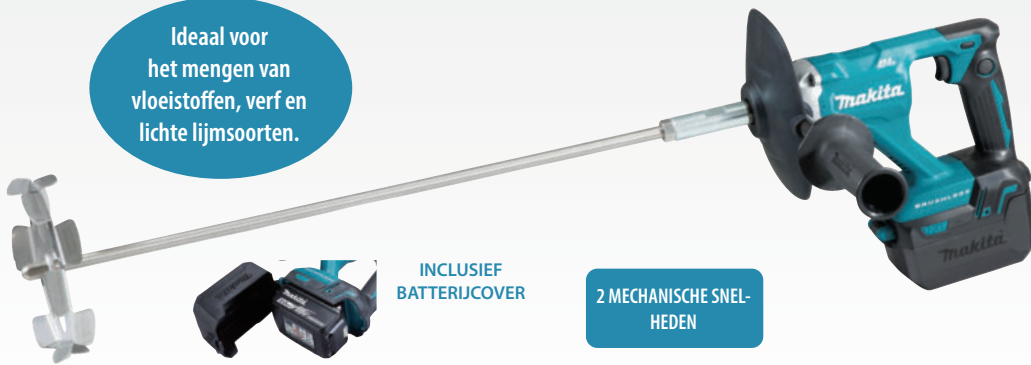

INCLUSIEF BATTERIJCOVER

2 MECHANISCHE SNELHEDEN

DUT130RTE

Spanning	18 V
Diameter mengblad	165 mm
Aansluiting	M12-M14
Toerental	0-350 / 0-1300 t.p.m.
Bijgeleverde accu's	2 x BL1850B
Gewicht	2,5 kg
Prijs in €	excl. btw
	incl. btw

ACCU LANGNEKSCHUURMACHINE 225 MM



Accessoires

Steunschijf

Type	Ref.	Prijs excl. btw	Prijs incl. btw
Zacht	199939-3		
Medium	199940-8		
Hard	199938-5		

Schuurschijf 225 mm (per 25)

Korrel	Ref.	Prijs excl. btw	Prijs incl. btw
P40	B-68389		
P80	B-68395		
P120	B-68404		
P180	B-68410		
P320	B-68426		



DSL801RTEU

DSL800ZU



Telescopische buis De totale lengte van de machine kan gevarieerd worden van 1100 tot 1520 mm



Verlengstuk

Met het optionele verlengstuk met steun (199937-7) kan langer comfortabel in de hoogte gewerkt worden.

DSL800ZU DSL801ZU DSL801RTEU

Spanning	18 V	18 V	18 V
AWS	✓	✓	✓
Bijgeleverde accu's	0	0	2 x BL1850B
Toerental onbelast	1000-1800 t.p.m.	1000-1800 t.p.m.	1000-1800 t.p.m.
Diameter schuurschijf	225 mm	225 mm	225 mm
Lengte	1100-1520 mm	1100-1520 mm	1100-1520 mm
Gewicht	4,8 kg	4,8 kg	4,8 kg
Prijs in €	excl. btw		
	incl. btw		



De beschermkap van de DSL800 heeft één rechte kant, dat laat toe dicht langs een muur of plafond te bewegen.



De beschermkap van de DSL801 is volledig rond, dit is gunstig voor de stofafvoer.

ACCU GIPSFREES



DCO181Z

Spanning	18 V
Toerental	0 - 32000 t.p.m.
AWS	✓ excl. Bluetooth unit
BL-Motor	✓
Bijgeleverde accu's	0
Gewicht	1,4 kg
Prijs in €	excl. btw
	incl. btw

ACCU GIPSAZAG



DSD180ZJ

Spanning	18 V
Slaglengte	6 mm
Bijgeleverde accu's	0
Gewicht	1,7 kg
Prijs in €	excl. btw
	incl. btw



ACCU SCHROEFAUTOMATEN



• **"Push Drive"-technologie:** de motor start automatisch wanneer de neus van de machine tegen de ondergrond wordt gedrukt.



DFR551RTJ



DFR550RTJ

	DFR550RTJ	DFR750Z	DFR452RTJ	DFR551RTJ
Spanning	18V	18V	18V	18V
Toerental	4000 t.p.m.	4000 t.p.m.	6000 t.p.m.	6000 t.p.m.
BL motor	-	-	✓	✓
Ø Gipsplaatschroef	4,0 mm	4,0 mm	3,5-4,2 mm	3,5-4,2 mm
Schroeflengte	25-55 mm	45-75 mm	20-41 mm	25-55 mm
"Push drive" technologie	-	-	✓	✓
Bijgeleverde accu's	2x BL1850B	0	2x BL1850B	2x BL1850B
Gewicht	2,1 kg	2,1 kg	2,2 kg	2,2 kg
Prijs in €	excl. btw			
	incl. btw			

ACCU SCHROEVENDRAAIERS



**Duw-aandraaistand ("Push drive")**



In de duw-aandraaistand gaan de motor en de schroefkop automatisch draaien wanneer er druk op wordt uitgeoefend.



DFS452FJX2



DFS250RTJ

	DFS250RTJ	DFS452RAJ	DFS452FJX2
Spanning	18 V	18 V	18 V
Toerental	0-2500 t.p.m.	0-4000 t.p.m.	0-4000 t.p.m.
Incl. schroeflintadapter	-	-	✓
Schroeflengte	-	-	25-55 mm
"Push drive" technologie	-	✓	✓
Bijgeleverde accu's	2 x BL1850B	2 x BL1820B	2 x BL1830B
Gewicht	1,5 kg	1,5 kg	1,5 kg
Prijs in €	excl. btw		
	incl. btw		

ACCU BOVEN- EN KANTENFREES



	DRT50ZJX3	DRT50RTJX3
Spanning	18 V	18 V
Max. induikdiepte	35 mm	35 mm
Toerental onbelast	10.000-30.000 t.p.m.	10.000-30.000 t.p.m.
Ø spantang - bereik	6 - 8 mm	6 - 8 mm
Ø spantang - inbegrepen	6 mm, 8 mm	6 mm, 8 mm
Bijgeleverde accu's	0	2 x BL1850B
Gewicht	2,1 kg	2,1 kg
Prijs in €	excl. btw	
	incl. btw	

ACCU HANDPALMVLAKSCHUURMACHINES



DBO480RTJ

DBO482RTJ

DBO481RTJ

DBO480: standaard met extra driehoekszool

	DBO480RTJ	DBO481RTJ	DBO482RTJ
Spanning	18V	18V	18V
Afmetingen schuurvoet	112 mm x 102 mm	112 mm x 102 mm	112 mm x 102 mm
Papierbevestiging	Klem/Velcro	Klem	Klem
Materiaal schuurvoet	Kunststof	Kunststof	Aluminium
Aantal schuurbewegingen	22000/28000 min <sup>-1</sup>	22000/28000 min <sup>-1</sup>	22000/28000 min <sup>-1</sup>
Schuuruitslag	1,5 mm	1,5 mm	1,5 mm
Bijgeleverde accu's	2x BL1850B	2x BL1850B	2x BL1850B
Gewicht	1,4-1,8 kg	1,4-1,8 kg	1,4-1,8 kg
Prijs in €	excl. btw		
	incl. btw		

ACCU VLAKSCHUURMACHINES



DBO381RTJU

- Afneembare voorhandgreep

	DBO380RTJ	DBO381RTJU
Spanning	18V	18V
Afmetingen schuurvoet	92 mm x 185 mm	92 mm x 185 mm
Aantal schuurbewegingen	8000/16000/24000 min <sup>-1</sup>	8000/16000/24000 min <sup>-1</sup>
Schuuruitslag	2,0 mm	2,0 mm
AWS	-	✓
Bijgeleverde accu's	2x BL1850B	2x BL1850B
Gewicht	1,9 - 2,2 kg	1,9 - 2,2 kg
Prijs in €	excl. btw	
	incl. btw	

ACCU EXCENTRISCHE SCHUURMACHINE 125 MM



DBO180

DBO180RTJ

	DBO180RTJ
Spanning	18V
Diameter schuurvoet	125 mm
Aantal schuurbewegingen	14000 - 22000 mm <sup>-1</sup>
Schuuruitslag	2,8 mm
Bijgeleverde accu's	2 x BL1850B
Gewicht	1,7 kg
Prijs in €	excl. btw
	incl. btw

ACCU EXCENTRISCHE POLIJSTMACHINES



DPO500Z

Vrije rotatie en geforceerde rotatie

	DPO500Z	DPO600Z
Spanning	18V	18V
Oscillatiefrequentie	0-13600 min <sup>-1</sup>	0-13600 min <sup>-1</sup>
Schuurvoet	125 mm	150 mm
Schuuruitslag	5,5 mm	5,5 mm
Bijgeleverde accu's	0	0
Gewicht	3,1 kg	3,1 kg
Prijs in €	excl. btw	
	incl. btw	

ACCU BANDSCHUURMACHINE 9 MM



Hoog gebruikskomfort en perfecte balans door centrale plaatsing van de motor

Richtbare led en zijhandgreep



Werkbereik 90° (met uiterste stand 160° voor het opbergen)

	DBS180RTJ
Spanning	18V
Bandsnelheid	600 - 1700 m/min
Schuurband	9 x 533 mm
Bijgeleverde accu's	2 x BL1850B
Gewicht	1,8 - 2,1 kg
Prijs in €	excl. btw
	incl. btw

ACCU MULTITOOL

Wist je dat er van DTM51 de voordelige uitvoeringen DTM51Z en DTM51T1JX2 bestaan? Zie p. 52-53 voor meer info!



STARLOCK



Gereedschapsloze accessoirewissel

DTM51RTJX2

STARLOCK STARLOCK PLUS STARLOCK MAX



DTM52 incl. accessoires

Promo DTM52RTJX1 : gratis afstandsbediening LD030P

DTM51 Inclusief: set van 9 accessoires, 30 schuurvellen, 1 afzuigset

DTM52

- Compatibel met Starlock, Starlock Plus en Starlock Max accessoires, ideaal voor de zwaardere toepassingen.
- Grote oscillatiehoek van 1,8° links/rechts
- Zeer lage trillingswaarden dankzij AVT technologie
- Kleine greepomtrek en laag gewicht

	DTM51RTJX2	DTM52RTJX1
Spanning	18 V	18 V
BL motor	-	✓
Oscillatiefrequentie	6000-20000 /min	10000-20000 /min
Oscillatiehoek	3,2°	3,6°
Opname	OIS, Starlock	Starlock, Starlock Plus, Starlock Max
Bijgeleverde accu's	2 x BL1850B	2 x BL1850B
Gewicht	2,0 kg	1,7 kg
Prijs in €	excl. btw	
	incl. btw	

STARLOCK



STARLOCK PLUS



STARLOCK MAX



Voor het totaal overzicht van het assortiment scan hier

- ✓ Snelle wissel van accessoires door een simpele klik
- ✓ Starlock Plus zaagbladen : snel, diep en veelzijdig invallend zagen
- ✓ Starlock Max zaagbladen : zelfs voor de meest veeleisende en zware toepassingen

• Starlock Plus en Starlock Max accessoires kunnen enkel gebruikt worden met de DTM52.

ACCU SCHUURPOLIJSTMACHINE 75 MM



**Polijsten**  
Steunschijf met velcro opname voor polijst toepassingen.



**Compact**  
Uiterst compacte machine met de handgreep kort bij de schijf voor een optimale controle.



DPV300RTJ

- Zeer compacte machine ideaal voor het schuren en polijsten van kleine oppervlakken.
- Twee mechanische versnellingen en traploze snelheidsregeling.
- Geleverd met velcro steunschijf voor het polijsten en een Roloc™ opname voor schuurtoepassingen.

• Accessoires

Steunschijf

Referentie	Omschrijving
191N90-9	Inpoetsschijf geel
191N91-7	Inpoetsschijf wit
191N92-5	Wollen polijstschijs
743125-4	Magic steunschijf om te polijsten 75mm velcro
743124-6	Roloc steunschijf om te schuren 46mm
743126-2	Adapter voor Roloc steunschijf 46mm
140X75-2	Handgreep
E-07412	Schuurschijf aluminiumoxide 50 mm A60 (25 st.)
E-07428	Schuurschijf aluminiumoxide 50 mm A80 (25 st.)
E-07434	Schuurschijf aluminiumoxide 50 mm A120 (25 st.)
E-07440	Schuurschijf zirconium 50 mm Z60 (25 st.)
E-07456	Schuurschijf zirconium 50 mm Z80 (25 st.)
E-07462	Vlieschijf zirconium Grof / Hard 50 mm (25 st.)
E-07478	Vlieschijf zirconium Medium / Hard 50 mm (25 st.)
E-07484	Vlieschijf zirconium Fijn / Hard 50 mm (25 st.)
E-07490	Vlieschijf zirconium Medium / Zacht 50 mm (25 st.)
E-07509	Vlieschijf zirconium Fijn / Zacht 50 mm (25 st.)
E-07515	Vlieschijf zirconium Zeer fijn / Zacht 50 mm (25 st.)



**Schuren**  
Roloc™ compatibele opname voor schuurtoepassingen.

DPV300RTJ

Capaciteit polijsten	80 mm
Capaciteit schuren	50 mm
Toerental polijsten	0-2800 min <sup>-1</sup>
Toerental schuren	0-9500 min <sup>-1</sup>
Bijgeleverde accu's	2 x BL1850
Gewicht	1,3 kg
Prijs in €	excl. btw
	incl. btw

ACCU BANDZAGEN



DPB180Z

Aluminium  
behuizing



DPB183



DPB184Z



DPB182Z

	DPB180Z	DPB182Z	DPB184Z	DPB183Z	DPB183RTE
Spanning	18V	18V	18V	18V	18V
Max. bandsnelheid	162 m/min	192 m/min	192 m/min	192 m/min	192 m/min
Capaciteit stalen buis	120 x 120 mm	64 x 64 mm	51 x 51 mm	66 x 66 mm	66 x 66 mm
BL-motor	-	-	✓	✓	✓
Bijgeleverde accu's	-	-	-	-	2 x BL1850B
Bijgeleverde lader	-	-	-	-	DC18RC
Gewicht	6,8 kg	3,8 kg	3,2 kg	3,8 kg	3,8 kg
Prijs in €	excl. btw				
	incl. btw				

ACCU METAALAFKORTMACHINE



DLW140PG2

Gereedschapsloze (hoek)verstelling  
van de geleider.

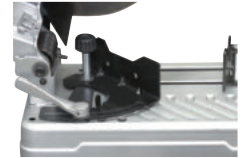

	DLW140Z	DLW140PG2
Spanning	2 x 18V	2 x 18V
Toerental onbelast	3800 t.p.m.	3800 t.p.m.
Diameter schijf	355 mm	355 mm
Bijgeleverde accu's	0	2 x BL1860B
Gewicht	16,9 kg	16,9 kg
Prijs in €	excl. btw	
	incl. btw	

ACCU BLINDKLINGNAGELPISTOLEN



Scan deze code  
voor uitgebreide  
technische info.

	DRV150J	DRV250J
Trekracht	10 kN	20 kN
Compatibel met blindklinknagel Ø	2,4 / 3,2 / 4,0 / 4,8 mm	4,8 / 6,0 / 6,4 mm
Slaglengte	25 mm	30 mm
Bijgeleverde accu's/lader	-	-
Gewicht	1,9 kg	2,1 kg
Prijs in €	excl. btw	
	incl. btw	

ACCU DOORSLIJPER



Dankzij de krachtige en efficiënte BL-motor wordt een uitstekende vermogen-gewichtsverhouding bereikt.

Maximale zaagdiepte 88 mm

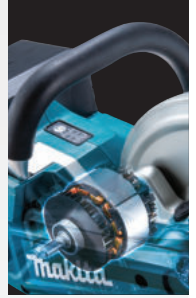

ACCESSOIRES

Ref	Type
E-03006	doorslijpschijf RVS 230 x 2,0 x 22,23 mm
E-02967	diamantschijf 230 mm x 2,4 x 22,23 mm



De gesegmenteerde diamantschijf E-02967 werd speciaal ontwikkeld voor het gebruik met een accu doorslijper. De diamantkorrels zijn gelijkmatig verdeeld en volgens een speciaal V-vormig patroon ingebed. Daardoor blijft de schijf continu scherp en zijn de zaagprestaties optimaal.

	DCE090ZX1	DCE090T2X1
Spanning	2 x 18 V	2 x 18 V
Ø schijf	230 mm	230 mm
Toerental onbelast	6600 min <sup>-1</sup>	6600 min <sup>-1</sup>
Max. zaagdiepte	88 mm	88 mm
Max. schijfdikte	3,0 mm	3,0 mm
Bijgeleverde accu's	0	2 x BL1850B
Lader	-	DC18RD
Gewicht	5.6 - 6.3 kg	5.6 - 6.3 kg
Prijs in €	excl. btw	
	incl. btw	

ACCU DIAMANTZAAG 125 MM



Kantelbaar tot 45°

Inclusief 2 stofkappen, voor droog en nat gebruik

Ideaal voor afwerking (steen, beton, keramiek)

	DCC501RTJ
Toerental onbelast	8500 min <sup>-1</sup>
AWS	✓ excl. Bluetooth unit
Diameter asgat	20 mm
Bijgeleverde accu's	2 x BL1850B
Gewicht	2,7 kg
Prijs in €	excl. btw
	incl. btw



DCC501RTJ



ACCU HAAKSE SLIJERS 125 MM

**ADT AFT** **BL MOTOR**

**18V LITHIUM-ION** **MAX PAC**

Wist je dat er van DGA506 en DGA508 de voordelige uitvoeringen DGA506Z / DGA506T1J en DGA508Z / DGA508T1J bestaan? Zie p. 52-53 voor meer info!



DGA506RTJ

DGA518RTJU

	DGA506RTJ	DGA508RTJ	DGA513RTJ	DGA517RTJ	DGA514RTJU	DGA518RTJU
--	-----------	-----------	-----------	-----------	------------	------------

Spanning	18V	18V	18V	18V	18V	18V
Ø schijf	125 mm	125 mm	125 mm	125 mm	125 mm	125 mm
Bijgeleverde accu's	2 x BL1850B	2 x BL1850B	2 x BL1850B	2 x BL1850B	2 x BL1850B	2 x BL1850B
Heropstartbeveiliging	✓	✓	✓	✓	✓	✓
Elektrische rem	✓	✓	✓	✓	✓	✓
Regelbaar toerental	-	-	✓	✓	✓	✓
AWS	-	-	-	-	✓	✓
Schakelaar	Schuifschakelaar met vergrendeling	Lepelschakelaar, zonder vergrendeling	Schuifschakelaar met vergrendeling	Lepelschakelaar, zonder vergrendeling	Schuifschakelaar met vergrendeling	Lepelschakelaar, zonder vergrendeling
Gewicht	2,5 kg	2,5 kg	2,5 kg	2,5 kg	2,5 kg	2,5 kg
Prijs in €	excl. btw					
	incl. btw					

BESCHERMKAP MET STOF AFZUIGING VOOR HAAKSE SLIJERS



230 mm



125 mm

196845-3

196845-3 198440-5

Diameter stofkap	125 mm	230 mm
Max. zaagdiepte	20 mm	60 mm
Prijs in €	excl. btw	
	incl. btw	

ACCU STEPELSLIJPER

**MAX PAC**



DGD800RTJ

Spanning	18V
Toerental	25000 t.p.m.
Ø spantang - bereik	6 - 8 mm
Ø spantang - inbegrepen	6 mm
Bijgeleverde accu's	2 x BL1850B
Gewicht	2,1 kg
Prijs in €	excl. btw
	incl. btw

ACCU HAAKSE SLIJERS 180-230 MM

**ADT AFT** **18V + 18V** **36V**



DGA900PG2

DGA701ZKU

	DGA701ZKU	DGA900ZK	DGA901ZKU	DGA900PG2	DGA901PG2U
--	-----------	----------	-----------	-----------	------------

Spanning	2 x 18V	2 x 18V	2 x 18V	2 x 18V	2 x 18V
Ø schijf	180 mm	230 mm	230 mm	230 mm	230 mm
AWS	✓	-	✓	-	✓
Bijgeleverde accu's	0	0	0	2 x BL1860B	2 x BL1860B
Gewicht	5,0 kg	5,2 kg	5,2 kg	5,2 kg	5,2 kg
Prijs in €	excl. btw				
	incl. btw				

ACCU HAAKSE SLIJPER 125 MM X-LOCK



DGA519RTJ

DGA521ZX1



Snel en veilig schijven bevestigen via een kliksysteem.



ACCESSOIRES X-LOCK

Referentie	Type	Prijs excl. btw	Prijs incl. btw
E-00393	Afbraamschijf voor metaal 125 mm x 6 x 22,23		
E-00402	Afbraamschijf voor inox 125 mm x 6 x 22,23		
E-00418	Doorslijpschijf voor inox 125 mm x 1,2 x 22,23		
E-02076	Diamantdoorslijpschijf 125 mm		
191G05-4	Beschermkap met stofafzuiging 125 mm		
D-73396	Komborstel voor metaal, gegolfde draad 75 mm x 0,3		
D-73433	Komborstel voor metaal, gegolfde draad, vermessigd 75 mm x 0,3		
D-73346	Komborstel voor inox, gegolfde draad 75 mm x 0,3		
D-73374	Komborstel voor metaal, getordeerde draad 80 mm x 0,35		
D-73380	Komborstel voor metaal, getordeerde draad 80 mm x 0,5		
D-73330	Komborstel voor inox, getordeerde draad 80 mm x 0,5		
D-73449	Kegelborstel voor metaal, gegolfde draad 100 mm x 0,3		
D-73411	Schijfborstel voor metaal, getordeerde draad 115 mm x 0,5		
D-73427	Schijfborstel voor metaal, gegolfde draad 115 mm x 0,3		
E-11776	Doorslijpschijf TCG 125 mm x 2 x 22,23 X-Lock		

	DGA521ZX1	DGA520ZX1	DGA519ZJ	DGA519RTJ
Spanning	18 V	18 V	18 V	18 V
Ø schijf	125 mm	125 mm	125 mm	125 mm
Bijgeleverde accu's	0	0	0	2 x BL1850B
Toerental onbelast	8500 min <sup>-1</sup>	8500 min <sup>-1</sup>	3000 - 8500 t.p.m.	3000 - 8500 t.p.m.
Heropstartbeveiliging	✓	✓	✓	✓
Elektrische rem	-	✓	✓	✓
Regelbaar toerental	-	-	✓	✓
Type schakelaar	Schuifschakelaar met vergrendeling	Lepelschakelaar zonder vergrendeling	Lepelschakelaar zonder vergrendeling	Lepelschakelaar zonder vergrendeling
Gewicht	2,4 - 3,0 kg	2,4 - 3,0 kg	2,5 kg	2,5 kg
Prijs in €	excl. btw			
	incl. btw			

ACCU KNABBELSCHAAR



DJN161RTJ

Spanning	18 V
Max. aantal snijbewegingen	1900 min <sup>-1</sup>
Max. dikte staal	1,6 mm
Bijgeleverde accu's	2 x BL1850B
Gewicht	2,2 kg
Prijs in €	excl. btw
	incl. btw

ACCU PLAATSCHAAREN



DJS130ZJ

DJS131Z

DJS200Z

DJS131: kan bochten en gegolfde staalplaat snijden



bij alle modellen kan de kop 360° gedraaid worden

DJS200: voor het knippen van rechte stukken met minimale vervorming

	DJS130ZJ	DJS200Z	DJS131Z
Spanning	18 V	18 V	18 V
BL-motor	-	✓	✓
Aantal zaagbewegingen	2800/min	0-3000/min	0-3000/min
Max. dikte staal	1,3 mm	2,0 mm	1,3 mm
Bijgeleverde accu's	-	-	-
Gewicht	2,3 - 2,6 kg	2,2 kg	2,0 kg
Prijs in €	excl. btw		
	incl. btw		

ACCU VLECHTMACHINE



DTR180ZJ



DTR181ZJ

Optioneel accessoire:  
handgreep 191M27-0



NIEUW

PROMO

promo : gratis  
DTR180ZJ bij  
aankoop van 18  
dozen 199137-9



DTR181ZJ

• Ontworpen voor het maken van grote verbindingen, tot (2 x 16 mm) + (2 x 13 mm) of 25 mm + 22 mm.

		DTR180ZJ	DTR181ZJ
Spanning		18 V / 14,4 V	18 V / 14,4 V
Vlechtcapaciteit		10 mm + 10 mm (2 x 13 mm) + (2 x 13 mm)	16 mm + 16 mm (2 x 16 mm) + (2 x 13 mm)
Draaddikte		0,8 mm	0,8 mm
Modus		Enkelvoudig/continu	Enkelvoudig/continu
Bijgeleverde accu's		0	0
Gewicht		2,3 kg	2,3 kg
Prijs in €	excl. btw		
	incl. btw		



Polyester draad: 191J59-9  
(100 m, Ø 0,8 mm) 50 stuks/doos



Vlechtdraad gegalvaniseerd: 191A57-9  
(100 m, Ø 0,8 mm) 50 stuks/doos



Vlechtdraad staal: 199137-9  
(100 m, Ø 0,8 mm) 50 stuks/doos

ACCU BETONTRILNAALDEN



DVR850Z

		DVR350ZK	DVR450Z	DVR850Z
Spanning		18 V	18 V	18 V
Lengte trilnaald		80 cm	120 cm	240 cm
Diameter trilnaald		25 mm	25 mm	25 mm
Bijgeleverde accu's		0	0	0
Gewicht		2,0 kg	2,3 kg	2,4 kg
Prijs in €	excl. btw			
	incl. btw			

ACCU KITPISTOOL



INCLUSIEF  
kokerhouder  
600 ml bij  
DCG180RAX



DCG180RA

DCG180RAX

300 ML

600 ML

300 ML

		DCG180RA	DCG180RAX
Spanning		18 V	18 V
Max. spuitdruk		5000 N	5000 N
Max. extrusiesnelheid		0-28 mm/s	0-28 mm/s
Bijgeleverde accu's		1 x BL1820B	1 x BL1820B
Gewicht		2,1 kg	2,4 kg
Prijs in €	excl. btw		
	incl. btw		



Voor gebruiksklaar afkorten zonder vonken

Mobiel afkorten



DSC102ZJ



DSC121ZK

Stationair afkorten



DSC102

	DSC102ZJ	DSC121ZK
Spanning	18 V	18 V
Snijcapaciteit	M6/M8/M10	M8/M10/M12
Inbegrepen messenset	M8/M10	M8
Bijgeleverde accu's	0	0
Gewicht	3,3 kg	5,7 kg
Prijs in €	excl. btw	
	incl. btw	

ACCU BETONIJSERZAAG

**BL ADT**  
MOTOR



DSC251ZK

Spanning	18 V
Snijcapaciteit	10-25 mm
Bijgeleverde accu's/lader	0
Gewicht	3,9 kg
Prijs in €	excl. btw
	incl. btw

ACCU HYDRAULISCHE BETONIJSERKNIPPERS

**BL** MOTOR **18V LITHIUM-ION**



DSC163ZK

DSC163ZK DSC191Z

Spanning	18 V	18 V
Snijcapaciteit	3 - 16 mm	3 - 20 mm
Bijgeleverde accu's/lader	-	-
BL-motor	✓	-
Gewicht	6,9 kg	11,1 - 11,2 kg
Prijs in €	excl. btw	
	incl. btw	

ACCU PONSMACHINE



DPP200ZK

Spanning	18 V
Max. diameter ponsgat	20 mm
Inbegrepen Ø	12 mm
Max. dikte staal	8 mm
Max. dikte inox	6 mm
Gewicht	10,5 kg
Prijs in €	excl. btw
	incl. btw

Werkt met standaard 400 g patronen of vet in bulk



Debietregeling: automatisch of traag (met hoogste druk)



DGP180RT

Hogedrukslang van 120 cm



DGP180Z

	DGP180Z	DGP180RT
Spanning	18V	18V
Maximale druk	690 bar	690 bar
Debiet	145-290 ml/min	145-290 ml/min
Bijgeleverde accu's	-	1 x BL1850B
Gewicht	4,8 kg	4,8 kg
Prijs in €	excl. btw	
	incl. btw	

**DVP181**

- Kan continu werken dankzij twee accu's in parallel
- Tweetraps pomp met hoog debiet

DVP181ZK



DVP180Z



	DVP180Z	DVP181ZK
Spanning	18V	18V, 2 accu's in parallel
Compressor	ééntraps olieafgedichte schottenpomp	Tweetraps olieafgedichte schottenpomp
Debiet	60 l/min	113 l/min
Eindvacuüm	20 Pa (150 micron)	3 Pa (22,5 micron)
Bijgeleverde accu/lader	-	-
Gewicht	2,9 kg	8,2 kg
Prijs in €	excl. btw	
	incl. btw	



DMP180Z



Standaard met verschillende ventieladapters

**Bedieningspaneel**

De DMP181 is uitgerust met een groot display met achtergrondverlichting.



DMP181Z

**DMP181**

- Drie modi: hoog debiet, laag debiet en "ball" mode om op een veilige manier speelballen op te blazen.
- Functie voor het aflaten van lucht indien de druk te hoog is.

	DMP180Z	DMP181Z
Spanning	18V	18V
Debiet	10 l/min	11 - 22 l/min
Max. druk	8,3 bar	11,1 bar
Bijgeleverde accu/lader	-	-
Gewicht	1,5 kg	2,5 - 2,8 kg
Prijs in €	excl. btw	
	incl. btw	

# BESPAAR MET ONZE COMBOPACKS

MACHINES IN COMBOPACK 18 V			MACHINES 2 x 18 V	ACCU	DC18RC	MAK- PAC	PRIJS IN €
							DLX2313X1
				1 x 			DLX2375T
				3 x 			DLX2289T3J
				3 x 			DLX2189T3J
				2 x 			DLX2440TJ
				3 x 			DLX2236TJ1
				3 x 		2 x 	DLX2235T3J
				3 x 			DLX2434TJ
				4 x 		3 x 	DLX2194PTJ
				3 x 			DLX2245PT1



# BESPAAR MET ONZE COMBOPACKS

	DHP486	DTD153	DHR243	DGA506	DHS660	DJV181	DTM51
DLX2418TJ							
DLX4159TJ							
DLX5070TJ							
DLX5071TJ							
DLX6115JX1							
DLX1036TJ1							
DLX1108TJ1							

## PROMO

Gratis batterij BL1850B  
meteen mee geleverd  
in de Makpac!

Combineer voordelig  
met deze aanbieding

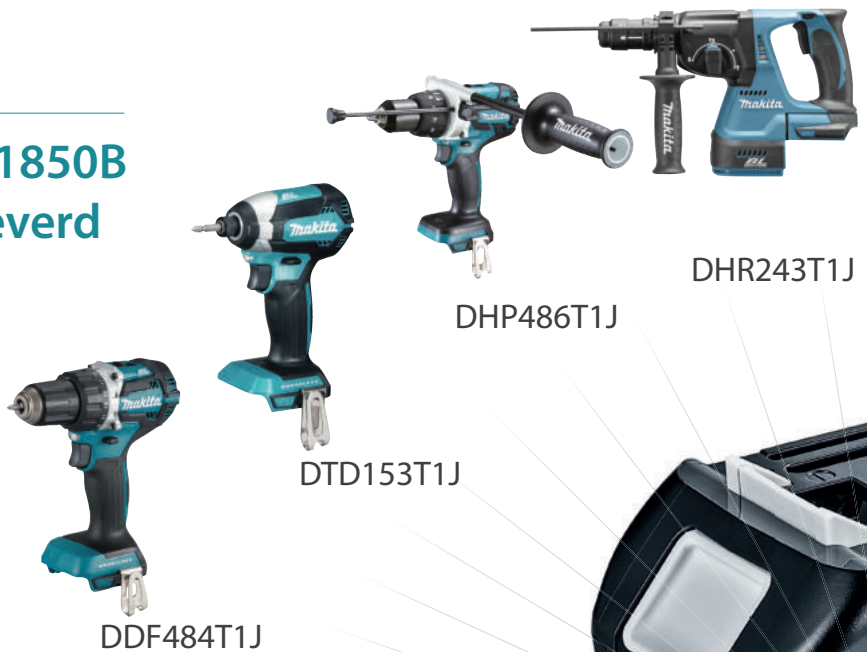

DDF484T1J

DTD153T1J

DHP486T1J

DHR243T1J



DTM51T1JX2





# TR0000001 TROLLEY



DJR188Z	DRT50JX3	DBO180ZJ	DDA351ZJ	BL1850B 18 V 5,0 Ah	DC18RC	KOFFER	PROMO	PRIJS IN €
				3 x 				
				3 x 			2 x	
				3 x 			3 x	
				3 x 			3 x	
				3 x 			4 x	
				5 x 	2 x 		9 x 	
				5 x 	2 x 		10 x 	



DHS680T1J



DTW300T1J



DJV181T1J



DJV182T1J

DGA506T1J



DGA508T1J



Deze modellen bestaan ook in een voordelige 'Z-versie' zonder accu, lader, Makpac of andere extra toebehoren.



# HET **LXT** -PLATFORM

## DJR189ZJ

Reciprozaag  
18 V



€ 189,00

Makpac

## DHG181ZJ

Hetelucht-  
pistool 18 V



Makpac

## DDF083ZJ

Boor- en schroefma-  
chine 1/4" 18 V



Makpac

## DDF485ZJ

Boor- en schroefma-  
chine 18 V



Makpac

## DDF482ZJ

Boor- en schroefma-  
chine 18 V



Makpac

## DDF484Z

Boor- en schroefma-  
chine 18 V



Karton

## DDF486ZJ

Boor- en schroefma-  
chine 18 V



Makpac

## DHP485ZJ

Klopboor- en  
schroefmachine 18 V



Makpac

## DHP484ZJ

Klopboor- en  
schroefmachine 18 V



Makpac

## DHP486Z

Klopboor- en  
schroefmachine 18 V



Karton

## DHR171ZJ

SDS+  
Boorhamer 18 V



Makpac

## DHR202ZJ

SDS+  
Boorhamer 18 V



Makpac

## DHR182ZJ

SDS+  
Boorhamer 18 V



Makpac

## DHR182ZWJ

SDS+ Boorhamer  
18 V + DX05



Makpac

## DHR243Z

SDS+  
Boorhamer 18 V



Karton

## DHR243ZJW

SDS+ Boorhamer  
18 V + DX07



Makpac

## DDA351ZJ

Haakse boorma-  
chine 18 V



Makpac

## DDA450ZK

Haakse  
boormachine 18 V



Koffer

## DHK180ZJ

Bikhamer  
SDS+ 18 V



Makpac

## DTD156Z

Slagschroeven-  
draaier 18 V



Karton

## DTD153Z

Slagschroeven-  
draaier 18 V



Karton

## DTD154ZJ

Slagschroeven-  
draaier 18 V



Makpac

## DTD157ZJ

Slagschroeven-  
draaier 18 V



Makpac

## DTD172ZJ

Slagschroeven-  
draaier 18 V



Makpac

**NIEUW**

## DTL061ZJ

Haakse  
slagschroevendraaier 18 V



Makpac

## DWR180ZJ

Ratelmoeisleutel  
18 V



Makpac

## DFS250ZJ

Schroefmachine  
18 V



Makpac

## DFS452ZJ

Schroefmachine  
18 V



Makpac

## DFR550ZJ

Schroef-  
automaat 18 V



Makpac

## DFR750Z

Schroef-  
automaat 18 V



Karton

## DFR452ZJ

Schroef-  
automaat 18 V



Makpac

## DFR551ZJ

Schroefautomaat  
18 V



Makpac

**NIEUW**

## DRV150ZJ

Blindklinknagel-  
pistool 18 V



Makpac

## DRV250ZJ

Blindklinknagel-  
pistool 18 V



Makpac

## DTW190ZJ

Slagmoersleutel 18 V



Makpac

## DTW180ZJ

Slagmoersleutel 18 V



Makpac

## DTW181ZJ

Slagmoersleutel 18 V



Makpac

## DTW300Z

Slagmoersleutel 18 V



Karton

## DTW700ZJ

Slagmoersleutel 18 V



Makpac

## DTW1001ZJ

Slagmoersleutel 18 V



Makpac

## DTW1002ZJ

Slagmoersleutel 18 V



Makpac

## DJV181Z

Decoupeerzaag  
18 V



Karton

## DJV184Z

Decoupeerzaag 18 V



Karton

## DJV182Z

Decoupeerzaag 18 V



Karton

## DJR183ZJ

Reciprozaag 18 V



Makpac

## DJR186ZK

Reciprozaag 18 V



Koffer

## DJR187ZK

Reciprozaag 18 V



Koffer

## DJR188ZJ

Reciprozaag 18 V



Makpac

## DCS552ZJ

Metaalcirkelzaag  
18 V



Makpac

## DCS553ZJ

Metaalcirkelzaag  
18 V



Makpac

## DHS680Z

Cirkelzaag 165 mm  
18 V



Karton

## DHS660ZJ

Cirkelzaag 165 mm  
18 V



Makpac

**DHS661ZJU**Cirkelzaag  
165 mm 18 V

Makpac

**DHS630ZJ**Cirkelzaag  
165 mm 18 V

Makpac

**DLS600Z**Afkort-verstekzaag  
165 mm 18 V

Karton

**DCC501ZJ**Diamantzaag  
125 mm 18 V

Makpac

**DGA506Z**Haakse slijper  
125 mm 18 V

Karton

**DGA508Z**Haakse slijper  
125 mm 18 V

Karton

**DGA513ZJ**Haakse slijper  
125 mm 18 V

Makpac

**DGA514ZJU**Haakse slijper  
125 mm 18 V

Makpac

**DGA517ZJ**Haakse slijper  
125 mm 18 V

Makpac

**DGA518ZJU**Haakse slijper  
125 mm 18 V

Makpac

**DGA521ZX1**Haakse slijper  
125 mm X-lock 18 V

Karton

**DGA520ZX1**Haakse slijper  
125 mm X-lock 18 V

Karton

**DGA519ZJ**Haakse slijper 125  
mm X-lock 18 V

Makpac

**DGD800ZJ**

Stempelslijper 18 V



Makpac

**DPJ180ZJ**

Lamellenfrees 18 V



Makpac

**DRT50ZJ**Boven- en  
kantenfrees 18 V

Makpac

**DST112ZJ**

Nietmachine 18 V



Makpac

**DST221ZJ**

Nietmachine 18 V



Makpac

**DPT353ZJ**Afwerkingpistool  
18 V

Makpac

**DFN350ZJ**Minibradpistool  
18 V

Makpac

**DBN500ZJ**

Minibradpistool 18 V



Makpac

**DBN600ZJ**

Bradpistool 18 V



Makpac

**DJN161ZJ**

Knabberschaar 18 V



Makpac

**DJS130ZJ**

Plaatschaar 18 V



Makpac

**DJS131Z**

Plaatschaar 18 V



Karton

**DJS200Z**Plaatschaar  
18 V

Karton

**DKP181ZU**

Schaaf 18 V



Karton

**DDA351ZJ**

Haakse boormachine 18 V



Makpac

**DSS501ZJ**

Cirkelzaag 136 mm 18 V



Makpac

**DCB200B**

Verwarmd deken 18 V



Karton

**DCO181Z**Gipsfrees  
18 V

Karton

**DSD180ZJ**

Gipszaag 18 V



Makpac

**DCG180ZK**

Kitpistool 18 V



Koffer

**DCG180ZXK**Kitpistool 18 V incl.  
kokerhouder

Koffer

**DTM51Z**Multitool  
18 V

Karton

**DTM52ZJ**Multitool  
18 V

Makpac

**DBO180ZJ**Excentrische  
schuurmachine 18 V

Makpac

**DBO380ZJ**Vlakschuur-  
machine 18 V

Makpac

**DBO381ZJU**Vlakschuur-  
machine 18 V

Makpac

**DBO480ZJ**Vlakschuurmachine  
18 V

Makpac

**DBO481ZJ**Vlakschuurmachine  
18 V

Makpac

**DBO482ZJ**Vlakschuurmachine  
18 V

Makpac

**DBS180ZJ**Bandschuurmachine  
9 mm 18 V

Makpac

**DPV300ZJ**Schuur- en polijst-  
machine 75 mm 18 V

Makpac

**DGP180Z**

Vetpomp 18 V



Karton

**DUT130Z**

Menger 18 V



Karton

**DHR264ZJ**Combihamer  
SDS+ 2 x 18 V

Makpac

**DWT310ZK**Breekmoersleutel  
2 x 18 V

Koffer

**DHS710ZJ**Cirkelzaag  
190 mm 2 x 18 V

Makpac

**DHS782ZJ**Cirkelzaag  
190 mm 2 x 18 V

Makpac

**DHS783ZJU**Cirkelzaag  
190 mm 2 x 18 V

Makpac

**DHS900Z**Cirkelzaag  
235 mm 2 x 18 V

Karton

**DHS900ZU**Cirkelzaag  
235 mm 2 x 18 V

Karton

**DSP600ZJ**Invalcirkelzaag  
165 mm 2 x 18 V

Makpac

**DJR360ZK**Reciprozaag  
2 x 18 V

Koffer

ACCU KOFFIEZETAPPARAAT



Ideaal voor op de bouw- en werkplaats. Werkt zowel met koffiepads als met gemalen koffie. Met één accu (LXT 5,0 Ah) maak je 3 koppen koffie van 160 ml.

DCM501Z

Spanning	10,8V/14,4V/18V	
Inhoud waterreservoir	240 ml	
Bereidingstijd met 18V accu (150 ml)	5 min.	
Bijgeleverde accu's	0	
Gewicht	1,9 - 2,2 kg	
Prijs in €	excl. btw	
	incl. btw	

ACCU WATERKOKER



- Dubbellaagse roestvrijstalen wand
- Met voedingsstandaard en groot handvat
- Uitgerust met morsbeveiliging

DKT360Z

Spanning	2x18V	
Inhoud	0,8 l	
Kooktijd voor 0,8 l	ca. 8 min	
Verwarmcapaciteit 100 °C	1,2 l met 2 x BL1850	
Gewicht	2,7 - 3,4 kg	
Prijs in €	excl. btw	
	incl. btw	

ACCU THERMO-ELEKTRISCHE KOELBOX



KOELEN EN VERWARMEN



Flexibele stroomvoorziening



Eén of twee 18 V LXT accu's in parallel

12 V / 24 V DC (auto)

Autonomie per acculading (2 x BL1860B)

-18 °C	5 °C	60 °C
≈ <b>5 uur</b>	≈ <b>17 uur</b>	≈ <b>4 uur</b>



-18 °C / -10 °C / 0 °C / 5 °C / 10 °C  
KOEL HOUDEN

55 °C / 60 °C  
WARM HOUDEN

DCW180Z

Voeding	18V LXT / AC / 12V DC - 24VDC	
Inhoud	20 liter	
Koelstanden	-18 °C / -10 °C / 0 °C / 5 °C / 10 °C	
Warm standen	55 °C / 60 °C	
Autonomie ca. (2x BL1860B)	-18 °C: 5uur, 5 °C: 17 uur, 60 °C: 4 uur	
Afmetingen	623 x 341 x 371.5 mm	
Gewicht	13,3 - 14,3 kg	
Prijs in €	excl. btw	
	incl. btw	



VERWARMDE JASSEN / BODYWARMERS CXT & LXT



CJ106 EN DCJ206:  
HIGH VISIBILITY  
(CONFORM  
ISO 20471/ANSI107)

CV102 EN DCV202:  
ZONDER MOUWEN  
(BODYWARMER)



CJ105  
DCJ205



CJ106  
DCJ206



CV102  
DCV202

	CJ105DZ	DCJ205Z	CJ106DZ	DCJ206Z	CV102DZ	DCV202Z
Maat	S-M-L-XL-2XL-3XL					
Spanning	10,8 V	18 V	10,8 V	18 V	10,8 V	18 V
Model	Jas - zwart	Jas - zwart	Jas - High Visibility	Jas - High Visibility	Bodywarmer	Bodywarmer
Vermogen	2,3W - 7W - 11,5W	2,3W - 7W - 11,5W	2,3W - 7W - 11,5W	2,3W - 7W - 11,5W	2,3W - 4,5W - 9,5W	2,3W - 4,5W - 9,5W
Verwarmingszones	5	5	5	5	4	4
Materiaal buitenzijde	Polyester	Polyester	Polyester	Polyester	Polyester Spandex	Polyester Spandex
Materiaal binnenzijde	Fleece	Fleece	Fleece	Fleece	Fleece	Fleece
Water- & windresistent	✓	✓	✓	✓	✓	✓
Machine wassen/drogen	✓	✓	✓	✓	✓	✓
Aantal zakken	6	6	6	6	4	4
Prijs in €	Excl. BTW					
	Incl. BTW					

ACCU VERWARMD DEKEN



CB100DB

**GESCHIKT VOOR  
WASMACHINE &  
DROOGKAST**

	CB100DB	DCB200B
Afmetingen (LxB)	700 x 1400 mm	
Vermogen	2,3 W - 4,5 W - 9,5 W	
Materiaal	Polyester	
Bijgeleverde accu's	0	0
Spanning	10,8 V	14,4 V/18 V
Prijs in €	excl. btw	
	incl. btw	

ACCU BLUETOOTH-SPEAKERS

12V max  
LITHIUM-ION

18V  
LITHIUM-ION



Equalizer

**DMR203**  
BLUETOOTH-SPEAKER  
MET KOPPELFUNCTIE

Koppelbaar  
per 2: True Wireless Stereo  
tot 10: simultaan luisteren



USB

Bluetooth

**DMR202**  
BLUETOOTH-SPEAKER  
MET MEDIASPELER

LCD-display

USB-  
mediaspeler

ACCU RADIO'S

XGT  
40V max  
Li-ION

12V max  
LITHIUM-ION

14.4V  
LITHIUM-ION

18V  
LITHIUM-ION

DAB+  
Bluetooth

NIEUW



**DMR056**  
RADIO MET LANTAARN LXT

DAB+  
Bluetooth



**DMR301**  
WERFRADIO CXT/LXT



- DMR301**
- Werkt met LXT/CXT accu's en op netstroom.
  - Laadfunctie voor LXT/CXT accu's
  - Met FM/DAB/DAB+ ontvanger
  - Uitgerust met Bluetooth voor het draadloos streamen
  - Twee USB uitgangen voor het opladen van mobiele apparaten.

DAB+  
Bluetooth



**DMR110N**  
WERFRADIO CXT / LXT

DAB+  
Bluetooth



**MR009GZ**  
RADIO MET  
LANTAARN XGT

NIEUW

MAKPAC ORGANIZER



**191X80-2**  
395 x 295 x 110 mm  
2.3 kg

- Inclusief 5 types van bakjes :  
150x150 mm (1), 150x100 mm (1),  
100x100 mm (2), 100x50 mm (3) en  
50x50 mm (6)
- Bijkomende inzetbakjes  
zijn apart te verkrijgen
- Flexibel indeelbaar
- Koppelbaar met Makita Makpacs,  
Makstors, Makpac trolley  
TR0000001 en Makpac transport-  
kar P-83886

DAB+  
Bluetooth



**MR003GZ**  
WERFRADIO  
XGT / LXT

DAB+  
Bluetooth



**MR004GZ**  
WERFRADIO  
XGT / LXT

DAB+  
Bluetooth



**MR007GZ**  
WERFRADIO  
XGT / LXT

GEREEDSCHAPSETS IN KOFFER

Onze favoriet!  
E-10883 : 221-delige gereedschapskoffer voor kleine herstellingen



Scan mij voor meer info!



**E-10883**  
GEREEDSCHAPSET  
221-DELIG



**E-06616**  
GEREEDSCHAPSKOFFER  
120-DELIG

WERKHANDSCHOENEN



NIEUW

Ref.	Maat	Specificaties		
P-84464	M	- Verhoogde bescherming tegen Impact (ANSI 2)		
P-84470	L	- Slijtvast		
P-84486	XL	- Touchscreen compatibel		
P-84492	XXL			

MAKSTORS



P-84311 Makstor nr. 3 met 4 lades.



P-84333 Makstor nr. 3 met 6 lades



P-84327 Makstor nr. 3 met 12 lades



P-84349 Makstor nr. 4 met 5 lades

Koppelbaar met alle Makita Makpacs, alsook met Makpac IV koelbox 198253-4, de Makpac trolley TR0000001 en de Makpac transportkar P-83886

De lades van de Makstor zijn flexibel indeelbaar. Standaard worden er bij deze Makstor 8 verdelers / tussenschotten geleverd. De lades zijn voorzien van een vergrendelingssysteem en kunnen gelabeld worden

IDEAAL OM LOSSE SPULLEN IN TE BEWAREN ZOALS BOREN EN BITSEN

Omschrijving	Ref.	Indeling	Afmetingen		
Makstor nr. 3-4	P-84311	4 lades (1 groot / 2 klein / 1 middelgrote)	395 (L) x 295 (B) x 210 (H) mm		
Makstor nr. 3-12	P-84327	12 kleine lades	395 (L) x 295 (B) x 210 (H) mm		
Makstor nr. 3-6	P-84333	6 middelgrote lades	396 (L) x 295 (B) x 210 (H) mm		
Makstor nr. 4-5	P-84349	5 lades (2 groot / 2 klein / 1 middelgrote)	395 (L) x 295 (B) x 320 (H) mm		

# LAMPEN

## ZAKLAMPEN CXT



	DEAML103	DEADML104	DEADML105	DEADML106
Spanning	10,8 V (12Vmax)	10,8 V (12Vmax)	10,8 V (12Vmax)	10,8 V (12Vmax)
Max. lichtstroom	100 lumen	710 lumen	190 lumen	190 lumen
Verlichtingssterkte op 1 m	50 lx	340 lx (0,5 m, lantaarn)	5500 lx	170 - 4500 lx
Werkingsduur bij max intensiteit, accu BL1041B	28 u.	5,5 u.	14 u.	12 u.
Specifieke functionaliteiten	Uiterst compact	Lantaarn (360°) en zaklamp (gericht) USB uitgang	Reflector in 12 posities verstelbaar	Zoom functie
Afmetingen	77 x 54 x 28 mm	414 x 66 x 132 mm	249 x 66 x 93 mm	271 x 66 x 93 mm
Gewicht	0,27 - 0,43 kg	0,61 - 0,78 kg	0,53 - 0,7 kg	0,61 - 0,78
Prijs in €	excl. btw			
	incl. btw			

## ZAKLAMPEN XGT



	DEAML001G	DEAML002G	DEAML006G	DEAML007G
Spanning	36 V (40Vmax)	36 V (40Vmax)	36 V (40Vmax)	36 V (40Vmax)
Max. lichtstroom	160 lumen	710 lumen	500 lumen	1000 lumen (flood)
Verlichtingssterkte op 1 m	3000 lx	340 lx	800 lx	520 lx (flood)
Werkingsduur bij max. intensiteit, accu BL4025	34 u.	10 u.	12,5 u	6,5 u (flood)
Specifieke functionaliteiten	Reflector in 12 posities kantelbaar	Lantaarn (360°) en zaklamp (gericht) USB uitgang	Reflector draaibaar en kantelbaar	Modi: spot, flood, spot + flood
Afmetingen	281 x 88 x 121 mm	370 x 86 x 126 mm	402 x 85 x 134 mm	273 x 120 x 106 mm
Gewicht	1,0 - 1,3 kg	1,2 - 1,5 kg	1,1 - 1,7 kg	1,6 - 2,9 kg
Prijs in €	excl. btw			
	incl. btw			

**DEADML105 - DEADML815 - DEAML001G**  
Reflector 170° kantelbaar in 12 stappen

170°



**DEADML104 - DEBDML806 - DEBDML807 - DEAML002G**

3 modi: 360° zijdelings licht, 180° zijdelings licht en gericht licht (bovenaan).  
USB uitgang Type A: 5V 2,4 A (behalve DEBDML806)

3 MODI



USB uitgang



**BEADML810**

Ontwerp met laag zwaartepunt zodat de lamp niet kan omvallen



## WERFLAMPEN LXT



	DEADML805	DEADML811	DEADML809	BEADML810	DML813	DML814
Spanning	18 V / 14,4 V / AC	18 V / 14,4 V / AC	18 V / 14,4 V / AC	18 V / 14,4 V / AC	18 V / 14,4 V	18 V / 14,4 V
Max. lichtstroom	750 lm	3000 lm	10000 lm	5500 lm	3000 lx	3000 lx
Verlichtingssterkte op 1 m	300 lx	1800 lx	3800 lx	550 lx	1250 lx	1250 lx
Verlichtingssterkte op 3 m	-	200 lx	380 lx	70 lx	130 lx	130 lx
Verlichtingssterkte op 5 m	-	85 lx	150 lx	25 lx	50 lx	50 lx
Verlichtingscapaciteit naar voor/zijdelings	-	6 m/6 m	10 m/10 m	360°, ± 4 m	4,5 m/5,3 m	4,7 m/5,6 m
Werkingsduur bij max intensiteit, accu BL1850B	8,5 u.	3 u.	1,4 u (2x BL1850B)	3,5 u.	3 u. (2x BL1850B)	3 u. (2x BL1850B)
Specifieke functionaliteiten	DC/AC 2 helderheidsniveaus	DC/AC 3 helderheidsniveaus	DC/AC 3 helderheidsniveaus	DC/AC 3 helderheidsniveaus	Geïntegreerd statief	Geïntegreerd statief Met 3 afzonderlijk richtbare lichtunits
Afmetingen	214 x 261 x 328 mm	249 x 302 x 361 mm	249 x 379 x 370 mm	420 x 420 x 787 mm	573 x 658 x 1250-2240 mm	573 x 658 x 1250-2240 mm
Gewicht	2,3 - 2,7 kg	4,1 - 4,8 kg	5,7 - 7,0 kg	13,9 - 15,3 kg	7,2 - 7,9 kg	7,4 - 8,1 kg
Prijs in €	excl. btw					
	incl. btw					

**DML813-DML814**  
Uitschuifbaar van 1250 mm tot 2240 mm  
Gemakkelijk opvouwbaar voor transport

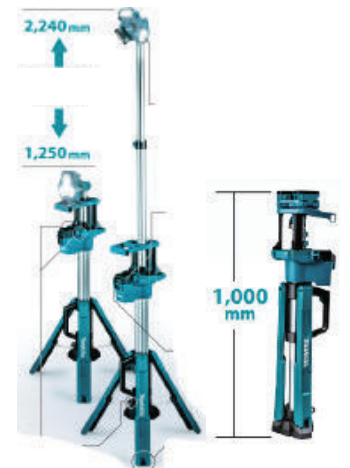

ZAKLAMPEN LXT



	DEADML803	DEADML186	DEADML800	DEADML815	DEADML808	DEBDML801	DEADML816	DEBDML806	DECDML807	DEBDML812
Spanning	18V/14,4V	18V/14,4V	18V/14,4V	18V/14,4V	18V/14,4V	18V/14,4V	18V/14,4V	18V/14,4V	18V/14,4V	18V/14,4V
Max. lichtstroom	170 lm	-	100 lm	160 lm	190 lm	240 lm	500 lm	620 lm (lantaarn)	710 lm (lantaarn)	1000 lm (flood)
Verlichtingssterkte op 1 m	270 lx (0,5 m)	500 lx	2000 lx	3000 lx	170 - 4500 lx	400 lx (0,5 m)	800 lx (1m)	310 lx (0,5 m, lantaarn)	340 lx (0,5 m, lantaarn)	520 lx (0,5 m flood)
Werkingsduur bij max intensiteit, accu BL1850B	26 u.	83 u.	33 u.	45 u.	26 u.	15 u.	75 h	21 u.	23 u.	6,5 u (flood)
Specifieke functionaliteiten	Batterijhouder met riembevestiging	Met handriem	Hoofdlamp	Reflector in 12 posities kantelbaar	Zoom functie	Reflector draaibaar en kantelbaar	Réflecteur rotatif et inclinable	Lantaarn (360°) en zaklamp (gericht)	Lantaarn (360°) en zaklamp (gericht) USB uitgang	Modi: spot, flood, spot + flood
Afmetingen	133 x 81 x 72 mm	151 x 81 x 61 mm	133 x 76 x 88 mm	256 x 79 x 99 mm	280 x 79 x 10 mm	380 x 79 x 116 mm	383 x 79 x 110 mm	365 x 78 x 119 mm	414 x 79 x 155 mm	313 x 119 x 115 mm
Gewicht	0,56 - 0,92 kg	0,51 - 0,83 kg	0,58 - 0,64 kg	0,26 - 0,93 kg	0,73 - 1,09 kg	0,61-0,98 kg	0,70 - 1,1 kg	0,69 - 1,1 kg	0,72 - 1,1 kg	1,2 - 1,6 kg
Prijs in €	excl. btw									
	incl. btw									

DEADML801- DEADML006G

De lichtkop is draaibaar, kantelbaar en opvouwbaar



**Lichtstroom (Lumen, lm):** de hoeveelheid uitgestraald licht per tijdseenheid. Het is een maat voor het vermogen van de lamp.

**Verlichtingssterkte (Lux, lx):** de lichtstroom per oppervlakte of dus de mate waarin een vlak verlicht wordt. De verlichtingssterkte is afhankelijk van de afstand tot de lichtbron.

**Verlichtingscapaciteit:** de zone waar de verlichtingssterkte minstens 70 lx is (de verlichtingssterkte die minimaal nodig is om veilig te kunnen werken).

Verlichtingscapaciteit

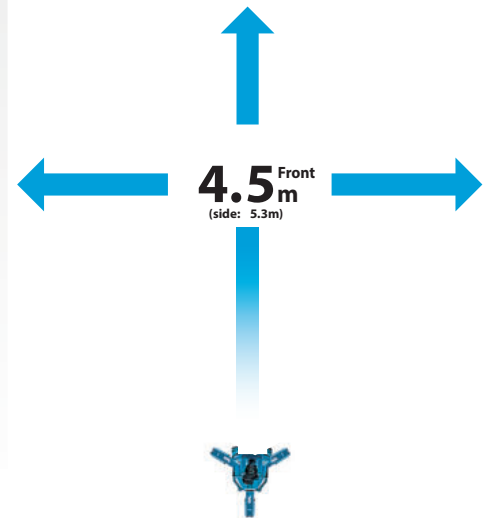

DML813



WERFLAMPEN LXT & XGT



NIEUW

NIEUW

	DEAML003G	DEAML005G	DEAML009G
Spanning	36V (40Vmax) /18V	36V (40Vmax) /18V	36V (40Vmax) /18V
Max. lichtstroom	1100 lm	3600 lm	10000 lm
Verlichtingssterkte op 1 m	500 lx	2100 lx	4300 lx
Verlichtingssterkte op 3 m	-	230 lx	500 lx
Verlichtingssterkte op 5 m	-	90 lx	110 lx
Verlichtingscapaciteit naar voor/zijdelings	2,8 m/3,0 m	6,0 m/6,4 m	9,7 m/11,4 m
Werkingsduur bij max intensiteit, accu BL4040	10 u.	3,5 u.	2,4 u.
Specifieke functionaliteiten	2 helderheidsinstellingen	3 helderheidsinstellingen	3 helderheidsinstellingen
Afmetingen	249 x 298 x 280 mm	248 x 309 x 296 mm	248 x 386 x 305 mm
Gewicht	3,7 - 4,7 kg	4,6 - 6,5 kg	6,4 - 9,9 kg
Prijs in €	excl. btw		
	incl. btw		

ACCESSOIRES



Statief voor DML805  
GM00001381



Spanvijs voor DML805  
GM00001396



Statief voor DML809 / DML811 / ML003G-  
GM00002073



Prijzen van accu's en laders geldig t.e.m. 31/12/2022

ACCU BL1021B  
12Vmax 2,0 Ah



197396-9

ACCU BL1041B  
12Vmax 4,0 Ah



197406-2

OPLADER DC105B



197363-4

OPLADER DC18RE



LXT CXT  
198720-9

Krachtig  
Compact  
Lichtgewicht

POWERPACK 12Vmax  
2 x 2,0 Ah



197658-5

POWERPACK 12Vmax  
2 x 4,0 Ah



197641-2

POWERPACK LXT + CXT



199026-8

POWERPACK LXT + CXT



199029-2



12Vmax  
LITHIUM-ION

10.8V  
LITHIUM-ION

ACCU BOOR- EN SCHROEFMACHINES

1/4" BITOPNAME



DF032DSAJ



DF033DWAJ



DF033DWAJ DF033DWMJ DF032DSAJ DF032DSMJ

Spanning	12Vmax	10,8 V	10,8 V	10,8 V
Hard koppel	30 Nm	30 Nm	35 Nm	35 Nm
BL-motor	-	-	✓	✓
Bijgeleverde accu's	2 x BL1021B	2 x BL1040B	2 x BL1020B	2 x BL1040B
Gewicht	0,9 kg	0,9 kg	0,9 kg	0,9 kg
Prijs in €	excl. btw			
	incl. btw			

ACCU BOOR- EN SCHROEFMACHINES



DF331DSMJ



DF333DNX10



Promo: gratis DEAML103 bij DF333DNX10

DF333DNX10

Accu boor- en schroefmachine	DF333
BL-motor	-
Bijgeleverde accu's	2 X BL1850B
Bijgeleverde accu's	1 x BL1021B
Lader	DC18RE
Prijs in €	excl. btw
	incl. btw

DF333DWAJ DF333DWMJ DF332DSAJ DF332DSMJ

Spanning	12Vmax	12Vmax	10,8 V	10,8 V
Hard koppel	30 Nm	30 Nm	35 Nm	35 Nm
BL-motor	-	-	✓	✓
Bijgeleverde accu's	2 x BL1021B	2 x BL1041B	2 x BL1020B	2 x BL1040B
Gewicht	1,1 kg	1,1 kg	1,2 kg	1,2 kg
Prijs in €	excl. btw			
	incl. btw			

ACCU KLOPBOOR- EN SCHROEFMACHINES



HP332DSMJ



HP331DWMJ



HP333DWAJ HP333DWMJ HP332DSAJ HP332DSMJ

Spanning	12Vmax	12Vmax	10,8 V	10,8 V
Hard koppel	30 Nm	30 Nm	35 Nm	35 Nm
BL-motor	-	-	✓	✓
Bijgeleverde accu's	2 x BL1021B	2 x BL1041B	2 x BL1020B	2 x BL1040B
Gewicht	1,1 kg	1,1 kg	1,1 kg	1,3 kg
Prijs in €	excl. btw			
	incl. btw			

ACCU BOORHAMERS SDS-PLUS



Model HR140DWYE1 met 65-delige BORENSET



HR166DSMJ



HR140DWYE1

	HR140DSAJ	HR140DSMJ	HR140DWYE1	HR166DSMJ
Spanning	10,8V	10,8V	12Vmax	10,8V
Slagenergie	1,0 J	1,0 J	1,0 J	1,1 J
Max. Ø beton	14 mm	14 mm	14 mm	16 mm
BL-motor	-	-	-	✓
Bijgeleverde accu's	2 x BL1020B	2 x BL1040B	2 x BL1015B	2 x BL1040B
Gewicht	1,9 kg	1,9 kg	1,9 kg	1,8 kg
Prijs in €	excl. btw			
	incl. btw			

ACCU HAAKSE BOORMACHINES



63 mm



DA332DSAJ

84 mm



DA333DSAJ



	DA332DSAJ	DA332DSMJ	DA333DSAJ	DA333DSMJ
Spanning	10,8V	10,8V	10,8V	10,8V
Boorkop	1,5-10 mm	1,5-10 mm	1,5-10 mm	1,5-10 mm
Bijgeleverde accu's	2 x BL1020B	2 x BL1040B	2 x BL1020B	2 x BL1040B
Gewicht	1,2 kg	1,2 kg	1,2 kg	1,2 kg
Prijs in €	excl. btw			
	incl. btw			

ACCU HAAKSE SLAGSCHROEVENDRAAIERS



Opname 1/4"

TL064DZJ



Opname 3/8"

TL065DZJ



	TL064DZJ	TL065DZJ
Spanning	10,8V	10,8V
Toerental	0-2000 t.p.m.	0-2000 t.p.m.
Bijgeleverde accu's	0	0
Gewicht	1,2 kg	1,2 kg
Prijs in €	excl. btw	
	incl. btw	



ACCU SLAGSCHROEVENDRAAIERS



10.8v



TD111DSMJ



TD110DSAJ



TD111DSAJ



Assist modus voor het vlot aanzetten bij het schroeven.

	TD111DZJ	TD110DSAJ	TD111DSAJ	TD110DSMJ	TD111DSMJ
Spanning	10,8 V	10,8 V	10,8 V	10,8 V	10,8 V
Max. koppel	135 Nm	110 Nm	135 Nm	110 Nm	135 Nm
BL-motor	✓	-	✓	-	✓
Assist modus	✓	-	✓	-	✓
Bijgeleverde accu's	0	2 x BL1020B	2 x BL1020B	2 x BL1040B	2 x BL1040B
Gewicht	1,0 kg	1,0 kg	1,0 kg	1,0 kg	1,0 kg
Prijs in €	excl. btw				
	incl. btw				

SCHROEFBITSET (35 STUKS) IMPACT BLACK



B-66880

Schroefbitset B-66880  
35 stuks Impact Black

ACCU SLAGMOERSLEUTELS



10.8v

12V<sup>max</sup>  
LITHIUM-ION



TW141DSMJ



TW161DSAJ

**Reverse Auto-stop:**  
Rotatie stopt automatisch wanneer de bout of moer is losgedraaid

	TW140DZJ	TW140DSAJ	TW140DSMJ	TW141DZJ	TW141DSMJ	TW160DZJ	TW160DSAJ	TW160DSMJ	TW161DZJ	TW161DSAJ	TW161DSMJ
Spanning	12Vmax	12Vmax	12Vmax	10,8 V	10,8 V	10,8 V	10,8 V	10,8 V	10,8 V	10,8 V	10,8 V
Toerental	0-2600 t.p.m.	0-2600 t.p.m.	0-2600 t.p.m.	0-2600 t.p.m.	0-2600 t.p.m.	0-1300 t.p.m. 0-2400 t.p.m.	0-1300 t.p.m. 0-2400 t.p.m.	0-1300 t.p.m. 0-2400 t.p.m.	0-1300 t.p.m. 0-2400 t.p.m.	0-1300 t.p.m. 0-2400 t.p.m.	0-1300 t.p.m. 0-2400 t.p.m.
Max. koppel	140 Nm	140 Nm	140 Nm	145 Nm	145 Nm	165 Nm	165 Nm	165 Nm	165 Nm	165 Nm	165 Nm
Snelheden	1	1	1	1	1	2	2	2	2	2	2
Auto-stop functie	-	-	-	-	-	✓	✓	✓	✓	✓	✓
Opname	3/8"	3/8"	3/8"	1/2"	1/2"	3/8"	3/8"	3/8"	1/2"	1/2"	1/2"
BL-motor	-	-	-	-	-	✓	✓	✓	✓	✓	✓
Bijgeleverde accu's	0	2 x BL1021B	2 x BL1041B	0	2x BL1041B	0	2 x BL1021B	2 x BL1041B	0	2 x BL1021B	2 x BL1041B
Gewicht	1,0 kg	1,0 kg	1,0 kg	1,1 kg	1,1 kg	1,0 kg	1,0 kg	1,0 kg	1,1 kg	1,1 kg	1,1 kg
Prijs in €	excl. btw										
	incl. btw										

ACCU RATELMOERSLEUTEL

**CXT** **10.8v**

Geleverd met  
1/4" & 3/8"  
opname

Verwijderbare kop laat toe  
om 13 mm moeren over de  
lengte van een M8 draad-  
stang te schroeven.



**WR100DZ**

Spanning	10,8 V
Toerental onbelast	800 t.p.m.
Max. koppel	47,5 Nm
Bijgeleverde accu's	-
Gewicht	1,0 kg
Prijs in €	excl. btw
	incl. btw

ACCU CIRKELZAAG 85 MM

**CXT** **MAK PAC** **10.8v**



HS301DSAJ

**HS301DSAJ** **HS301DSMJ**

Spanning	10,8 V	10,8 V
Max. zaagdiepte bij (90°)	25,5 mm	25,5 mm
Bijgeleverde accu's	2 x BL1020B	2 x BL1040B
Ø Zaagblad	85 mm	85 mm
Gewicht	1,6 kg	1,6 kg
Prijs in €	excl. btw	
	incl. btw	

ACCU TEGELSNIJDER 85 MM

**CXT** **MAK PAC** **10.8v**



CC301DSMJ



**CC301DZJ** **CC301DSMJ**

Spanning	10,8 V	10,8 V
Zaagdiepte (90°)	25,5 mm	25,5 mm
Ø Zaagblad	85 mm	85 mm
Bijgeleverde accu's	-	2 x BL1040B
Gewicht	1,9 kg	1,9 kg
Prijs in €	excl. btw	
	incl. btw	

ACCU DRAADSTANGKNIPPER **10.8v**

**10.8v**



Voor  
gebruiksklaar  
afkorten zonder  
vonken!

**SC103DZJ**

Spanning	10,8 V
Afkorten	Mobiel
Snijcapaciteit	M6 - M8 - M10
Inbegrepen mes	M8, M10
Bijgeleverde accu's	-
Gewicht	2,7 kg
Prijs in €	excl. btw
	incl. btw

ACCU MULTICUTTER **10.8v**

**10.8v**



**CXT** **MAK PAC**



**CP100DZJ**

Spanning	10,8 V
Snijcapaciteit	6 mm
Bijgeleverde accu's	-
Gewicht	0,72 kg
Prijs in €	excl. btw
	incl. btw

ACCU GIPSAZAG **10.8v**

**10.8v**



**CXT** **MAK PAC**



**SD100DZJ**

Spanning	10,8 V
Slaglengte	6 mm
Snijcapaciteit	30 mm
Bijgeleverde accu's	-
Gewicht	1,5 kg
Prijs in €	excl. btw
	incl. btw

ACCU DECOUPEERZAGEN

10.8v CXT

MAK PAC



JV102DSAJ



JV103DSAJ

	JV102DZJ	JV103DZJ	JV101DSAJ	JV102DSAJ	JV102DSMJ	JV103DSAJ	JV103DSMJ
Spanning	10,8V	10,8V	10,8V	10,8V	10,8V	10,8V	10,8V
Aantal zaagbewegingen	800-3000 /min	800-3000 /min	0-2900 /min	800-3000 /min	800-3000 /min	800-3000 /min	800-3000 /min
Max. capaciteit hout	90 mm	90 mm	65 mm	90 mm	90 mm	90 mm	90 mm
BL-motor	✓	✓	-	✓	✓	✓	✓
Bijgeleverde accu's	0	0	2 x BL1020B	2 x BL1020B	2 x BL1040B	2 x BL1020B	2 x BL1040B
Gewicht	1,8 kg	1,8 kg	1,8 kg	1,8 kg	1,8 kg	1,8 kg	1,8 kg
Prijs in €	excl. btw						
	incl. btw						

ACCU RECIPROZAAG

10.8v CXT MAK PAC



JR103DSAJ

	JR103DSAJ	JR103DSMJ
Spanning	10,8V	10,8V
Max. zaagcapaciteit hout/stalen buis	50 mm	50 mm
Bijgeleverde accu's	2 x BL1020B	2 x BL1040B
Gewicht	1,3 kg	1,5 kg
Prijs in €	excl. btw	
	incl. btw	

ACCU MULTITOOl

10.8v CXT MAK PAC



TM30DSAJX3

Spanning	10,8V
Oscillatiehoek	3,2°
Oscillatiefrequentie	6000-20000 min <sup>-1</sup>
Opname	OIS, Starlock
Bijgeleverde accu's	2 x BL1020B
Gewicht	1,1 kg
Prijs in €	excl. btw
	incl. btw

ACCU KITPISTOOL

CXT 10.8v MAK PAC



CG100DSAEA

CG100DSAEB

CG100DSAEB met aluminium kokerhouder 600 ml (voor worsten of kit in bulkverpakking)

	CG100DSAEA	CG100DSAEB
Spanning	10,8V	10,8V
Max. extrusiekracht	5000 N	5000 N
Max. extrusiesnelheid	0-28 mm/s	0-28 mm/s
Bijgeleverde accu's	2 x BL1020B	2 x BL1020B
Prijs in €	excl. btw	
	incl. btw	

ACCU NIETMACHINE



ST113DSAJ

Met repeteerfunctie en anti-droogschietmechanisme

	ST113DZJ	ST113DSAJ	ST113DSMJ
Spanning	10,8 V	10,8 V	10,8 V
Rugbreedte niet	10 mm	10 mm	10 mm
Ladercapaciteit	150 stuks	150 stuks	150 stuks
Bijgeleverde accu's	-	2 x BL1020B	2 x BL1040B
Gewicht	1,3 kg	1,3 kg	1,5 kg
Prijs in €	excl. btw		
	incl. btw		

ACCU PINTACKER



PT354DZJ

	PT354DZJ
Spanning	10,8 V
Draadkaliber	23 Ga
Doorsnede nagel	0,6 mm
Lengte nagel	15-35 mm
Bijgeleverde accu's	-
Gewicht	2,0 kg
Prijs in €	excl. btw
	incl. btw

ACCU SCHUURPOLIJSTMACHINE 75 MM



PV301DZJ

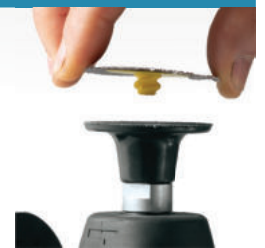

- Geleverd met adapter voor Roloc™ voor schuurtoepassingen en een velcro steunschijf voor het polijsten
- Ideaal voor oppervlaktebehandeling en voor het polijsten van kleine oppervlakken

	PV301DZJ	PV301DSAEJ
Spanning	10,8 V	10,8 V
Capaciteit polijsten	80 mm	80 mm
Capaciteit schuren	50 mm	50 mm
Toerental polijsten	0-2800 min <sup>-1</sup>	0-2800 min <sup>-1</sup>
Toerental schuren	0-9500 min <sup>-1</sup>	0-9500 min <sup>-1</sup>
Bijgeleverde accu's	-	2x BL1021B
Gewicht	1,1 kg	1,1 kg
Prijs in €	excl. btw	
	incl. btw	

LUCHTPOMP

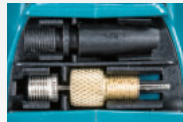

Standaard met verschillende ventieladapters



Ingebouwde ledverlichting



Aanduiding in psi, bar of kPa

Digitale aanduiding van de druk. Display met back light.

Instelling van de gewenste druk. De pomp stopt automatisch bij de ingestelde waarde.



MP100DZ

Spanning	10,8 V
Debiet	10 l/min (bij 2 bar)
Max. druk	8,3 bar
Bijgeleverde accu's	-
Gewicht	1,2 kg
Prijs in €	excl. btw
	incl. btw

COMBOPACK CXT

10.8v



promo: DEAML103

CLX228SAX2

Spanning	10,8 V
Bijgeleverde accu's	3 x BL1021B
Batterijlader	DC105B
Slagschroevendraaier	TD110D
Klopboor- en schroefmachine	HP333D
Prijs in €	excl. btw
	incl. btw

COMBOPACK CXT

10.8v



CLX400SAJ1

Spanning	10,8 V
Bijgeleverde accu's	3 x BL1020B
Slagschroevendraaier	TD110D
Boor- en schroefmachine	DF331D
Cirkelzaag	HS301D
Reciprozaag	JR103D
Batterijlader	DC105A
Prijs in €	excl. btw
	incl. btw

COMBOPACK CXT

10.8v



CLX206SAX3

Spanning	10,8 V
Bijgeleverde accu's	2 x BL1020B
Boor- en schroefmachine	DF331D
Multitool	TM30D
Batterijlader	DC105A
Prijs in €	excl. btw
	incl. btw

## Cycloonmodule

- ✓ Het grove stof wordt van het fijne stof gescheiden.
- ✓ Stofzak of capsule tot 80 % minder vaak ledigen!



191D71-3



## Cycloonmodule

De cycloonmodule wordt in lijn met de stofzuiger geplaatst. De centrifugale werking zorgt ervoor dat tot 80 % van het stof in de capsule opgevangen wordt vooraleer het de stofzuiger bereikt. Daardoor verhoogt de totale opvangcapaciteit en blijft de maximale zuigkracht van de machine langer behouden. Het reservoir van de module is zeer gemakkelijk te ledigen en uit te wassen.

Gemakkelijk te ledigen



Extra opvangcapaciteit  
**400 ml**

### OPTIONELE ACCESSOIRES



Muurbevestiging  
199971-7



Cycloonmodule (zwart)  
191D73-9



Vloerzuigmond tapijt  
198527-3



Kierzuigmond lang  
198990-0

## Accu steelstofzuiger

De DCL280 is een bijzonder lichte steelstofzuiger met BL-motor die gebruik maakt van een Makita 18 V LXT-accu. (DCL280FZ wordt geleverd in de Makita blauwe kleur.)



DCL280

Geluidsniveau  
**70 dB (A)**

Schuifschakelaar die geblokkeerd kan worden voor continu werken

Ledverlichting

De stofzuiger bevat een filter die gemakkelijk gereinigd kan worden. Er komt geen stofzak aan te pas.

BL-motor met hoog vermogen en hoge betrouwbaarheid

Vergrendeling van de pijp

### CLEANING COMBOPACK



#### CLX245SAX1

Spanning	10,8 V
Steelstofzuiger	CL108FDZW
Blaas-/ zuigmachine	UB100DZ
Meegeleverde accu's	1 x BL1021B
Lader	DC105B
Gereedschapstas	✓
Prijs in €	excl. btw
	incl. btw

### ACCU CYCLOONSTOFZUIGER



DCL501Z

#### DCL501Z

Spanning	18 V
Max. debiet	1,3 m <sup>3</sup> /min
Max. onderdruk	66 mbar
Bijgeleverde accu's	0
Gewicht	3,1 kg
Prijs in €	excl. btw
	incl. btw

STEELOSTOFZUIGERS CXT/ LXT



promo:  
DCL182: gratis cycloon 199491-1  
DCL280: gratis cycloon 191D71-3



NIEUW

NIEUW

NIEUW

NIEUW

	CL102DW	CL107FDZW	DCL180ZB	DCL182Z	DCL280FZ	DCL280FZW	DCL282FZ
Spanning	10,8 V	10,8 V (CXT)	18 V (LXT)	18 V (LXT)	18 V (LXT)	18 V (LXT)	18 V (LXT)
Max. debiet	0,9 m³/min	1,4 m³/min	1,4 m³/min	1,4 m³/min	1,5 m³/min	1,5 m³/min	1,5 m³/min
Max. onderdruk	23 mbar	50 mbar	42 mbar	54 mbar	60 mbar	60 mbar	82 mbar
Stofopvang	Stofzak	Stofzak	Capsule	Stofzak	Capsule	Capsule	Stofzak
Klikvergrendeling	-	-	-	-	✓	✓	✓
BL motor	-	-	-	-	✓	✓	✓
Bijgeleverde accu's	1 x BL1013	-	-	-	-	-	-
Kleur	Wit	wit	Zwart	Blauw	Blauw	Wit	Blauw
Gewicht	1,1 kg	1,1 kg	1,2 kg	1,3 kg	1,3 kg	1,3 kg	1,4 kg
Prijs in €	excl. btw						
	incl. btw						

	CL117FDX2	CL117FDX5	CL117FDX8	CL114FDWIX
Spanning	10,8 V	10,8 V	10,8 V	10,8 V
Max. debiet	1,0 m³/min	1,0 m³/min	1,0 m³/min	1,4 m³/min
Max. onderdruk	50 mbar	50 mbar	50 mbar	34 mbar
Stofopvang	Capsule	Capsule	Capsule	Stofzak
Klikvergrendeling	✓	✓	✓	✓
Bijgeleverde accu's	Geïntegreerd	Geïntegreerd	Geïntegreerd	Geïntegreerd
Kleur	Turquoise	Groen	Purper	Beige
Promo	-	-	-	-
Gewicht	1,0 kg	1,0 kg	1,0 kg	0,94 kg
Prijs in €	excl. btw			
	incl. btw			

XGT STEELOSTOFZUIGERS



CL003G

- Met geïntegreerde bovenaan geplaatste cycloonmodule
- De cycloonmodule vangt tot 80 % van het grove stof op, zodat de fijnfilter minder vaak gereinigd moet worden en de optimale zuigkracht langer behouden blijft.
- Stiller dankzij een herterkend design en gebruik van geluidsabsorberend materiaal.



NIEUW

NIEUW

	CL001GZ05	CL001GD208	CL002GZ03	CL002GD205	CL002GZ07	CL002GD212	CL003GZ04	CL003GD202
Spanning	40Vmax	40Vmax	40Vmax	40Vmax	40Vmax	40Vmax	40Vmax	40Vmax
Max. debiet	1,2 m³/min	1,2 m³/min	1,2 m³/min	1,2 m³/min	1,2 m³/min	1,2 m³/min	1,0 m³/min	1,0 m³/min
Max. onderdruk	210 mbar	210 mbar	210 mbar	210 mbar	210 mbar	210 mbar	200 mbar	200 mbar
Stofopvang	Capsule	Capsule	Stofzak	Stofzak	Stofzak	Stofzak	Cycloon-capsule	Cycloon-capsule
Klikvergrendeling	✓	✓	✓	✓	✓	✓	✓	✓
Bijgeleverde accu's	-	2x BL4025	-	2x BL4025	-	2x BL4025	-	2x BL4025
Kleur	Turquoise	Turquoise	Zwart	Zwart	Wit	Wit	Zwart	Zwart
Gewicht	1,7 - 2,3 kg	1,7 - 2,3 kg	1,7 - 2,3 kg	1,7 - 2,3 kg	1,7 - 2,3 kg	1,7 - 2,3 kg	1,9 - 2,5 kg	1,9 - 2,5 kg
Prijs in €	excl. btw							
	incl. btw							

# Technologie



Auto-start wireless system

## Geniet van stofvrij werken met AWS!

Bij het starten van de accumachine wordt de stofafzuiging automatisch geactiveerd d.m.v. een Bluetooth verbinding. Wanneer het verbonden toestel uitgeschakeld wordt, gaat de stofzuiger weer in stand-by modus. Sommige accustofzuigers zoals VC009 of DVC867 hebben AWS reeds standaard ingebouwd en kunnen dus rechtstreeks communiceren met AWS-compatibele gereedschappen.

Via de optionele adapter WUT02U kunnen nu ook stofzuigers op netstroom draadloos aangestuurd worden, ongeacht het merk. De enige vereiste is dat de stofzuiger met een startautomatiek uitgerust is.

AWS-compatibele stofzuiger



DVC867L

Stofzuiger met startautomatiek



+



Adapter WUT02U 199773-1



Bluetooth unit 198900-7



ACCU BLAAS- EN ZUIGMACHINE



**UB101DZ & DUB186:**  
uitvoering met lange pijp,  
ideaal om laag bij de grond  
te blazen.



DUB186Z

DUB185Z

	UB100DZ	UB101DZ	DUB185Z	DUB186Z
Spanning	10,8 V	10,8 V	18 V	18 V
Max. lichtsnelheid	75 m/s	65 m/s	98 m/s	68 m/s
Max. debiet	2,6 m³/min	2,6 m³/min	3,2 m³/min	3,2 m³/min
Gewicht	1,4 kg	1,4 kg	1,6 kg	1,6 kg
Prijs in €	excl. btw			
	incl. btw			

UB101DZ & DUB186Z : Prijzen geldig t/m 31/12/2022

BLAAS- EN ZUIGMACHINE



Multifunctionele schakelaar  
met snelheidsinstelling

UB1103

Vermogen	600 W
Max. lichtsnelheid	91 m/s
Max. debiet	4,1 m³/min
Gewicht	2,0 kg
Prijs in €	excl. btw
	incl. btw



ACCU RUGGEDRAGEN STOFZUIGERS



**DVC660**  
Uitvoering speciaal voor schoonmaak, geleverd met diverse accessoires.

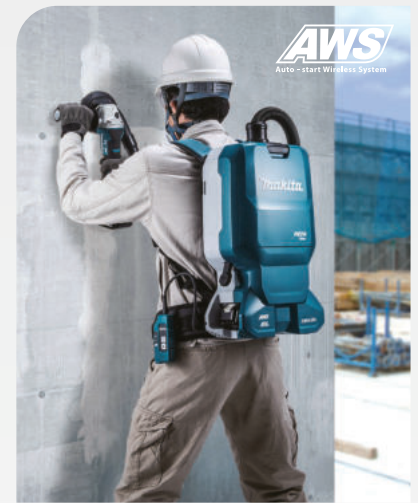

**DVC665**  
Uitvoering voor stofafzuiging in combinatie met machines.



**HEPA-filter**

Als hoofdfilter wordt een HEPA-filter gebruikt die zeer fijne stofdeeltjes effectief tegenhoudt. De filter kan tot 99,97 % van de deeltjes tussen 0,3 en 1 µm filteren, waardoor de uitgeblazen lucht zeer zuiver is.



**Filterreiniging**

Door de trillingen van het stappen of het manueel indrukken van de hendel wordt het fijn stof van de papierfilter geschud. Daardoor blijft de zuigkracht langer optimaal bij het opzuigen van fijn stof.



**DVC265ZXU DVC261ZX11 DVC660Z DVC665ZX1U**

Spanning	2 x 18 V	2 x 18 V	2 x 18 V	2 x 18 V
Max. debiet	1,8-2,2 m <sup>3</sup> /min	1,8-2,2 m <sup>3</sup> /min	1,8-2,2 m <sup>3</sup> /min	1,8-2,2 m <sup>3</sup> /min
Max. onderdruk	110 mbar	110 mbar	110 mbar	110 mbar
Uitvoering	Stofafzuiging machines	Schoonmaak	Schoonmaak	Stofafzuiging machines
Capaciteit stofzak	2 l	2 l	6 l	6 l
AWS	✓	-	-	✓
Gewicht	3,9 kg	3,8 kg	6,1 kg	6,1 kg
Prijs in €	excl. btw			
	incl. btw			

ACCU RUGGEDRAGEN STOFZUIGERS XGT



VC008GZ



VC009GZ  
(Geleverd zonder batterijen en zonder oplader)

- Hogere zuigkracht dankzij de 40Vmax accutechnologie
- Geluidsarm door een herterkend design van de luchtuitlaat en gebruik van geluidsabsorberend materiaal.
- VC008GZ wordt standaard geleverd met accessoires voor schoonmaakteoepassingen.
- VC009GZ01 wordt geleverd met twee zuigslangen en hulpstukken voor stofafzuiging in combinatie met machines.

**NIEUW NIEUW**  
**VC008GZ VC009GZ01**

Spanning	40Vmax	40Vmax
Max. debiet	2,4 m <sup>3</sup> /min	1,9 m <sup>3</sup> /min
Max. onderdruk	180 mbar	180 mbar
Uitvoering	Schoonmaak	Stofafzuiging machines
Capaciteit stofzak	2,0 l	2,0 l
AWS	-	✓
Gewicht	4,1 - 5,3 kg	4,1 - 5,3 kg
Prijs in €	excl. btw	
	incl. btw	

ACCU RECHTOPSTAANDE STOFZUIGER

18V + 18V → 36V

Met roterende borstel, ideaal voor tapijt  
Aparate motor voor het aandrijven van de borstel  
Telescopische aluminium steel



Met aparte aluminium buis om moeilijk bereikbare plaatsen te reinigen



Zeer wendbaar, geen voedingskabel en geen zuigslang!

3 vermogenstanden



Instelbare hoogte van de borstel (4 hoogtes, max 10 mm)



DVC560Z

Spanning	2 x 18V	
Max. debiet	1,9 m³/min	
Max. onderdruk	120 mbar	
Bijgeleverde accu's	0	
Gewicht	8,3 kg	
Prijs in €	excl. btw	
	incl. btw	

ACCU COMPACTE STOFZUIGER

LXT 18V LITHIUM-ION



Inclusief draagriem, vloerzuigmond & kierzuigmond

DVC750LZX1

Spanning	18V	
Max. debiet	1,4 m³/min	
Max. onderdruk	64 mbar	
Bijgeleverde accu's	0	
Gewicht	4,2 kg	
Prijs in €	excl. btw	
	incl. btw	

ACCU COMPACTE STOFZUIGER

12V max LITHIUM-ION

18V LITHIUM-ION

IDEAAL VOOR DE AUTO



DCL184Z

Met blaasfunctie

Inclusief accessoires

	CL121DZJ	DCL184Z	DCL184RF
Spanning	10,8V	18V	18V
Max. debiet	1,3 m³/min	1,3 m³/min	1,3 m³/min
Max. onderdruk	44 mbar	47 mbar	47 mbar
Bijgeleverde accu's	0	-	1 x BL1830B
Lader	-	-	DC18RC
Gewicht	1,7	2,1 kg	2,1 kg
Prijs in €	excl. btw		
	incl. btw		

Zuigmond voor matten



Zuigmond voor zetels



Rubberen zuigmond



Zachte borstel



Blaasmond



**DRC200**

- Verschillende sensoren voor obstakel- en grensdetectie
- Patroonmodus voor grote vloeroppervlakken met weinig obstakels, zoals een magazijn of een lange gang
- Willekeurige modus voor vloeroppervlakken met veel obstakels, zoals in een kantoor.
- Door middel van grenstape kan de gebruiker de zone afbakenen waarbinnen de robot mag werken.
- Modi "alleen borstelen" of "stofzuigen + borstelen"
- Bediening op het toestel zelf of met bijgeleverde afstandsbediening
- Werkt op één 18 V accu of twee in parallel. De accu's moeten uit het toestel verwijderd worden om op te laden.



DRC200PTJ

OPPERVLAKTE  
TOT 500 m<sup>2</sup>

**Patroonmodus**

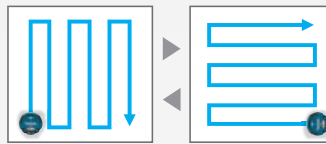

**Willekeurige modus**

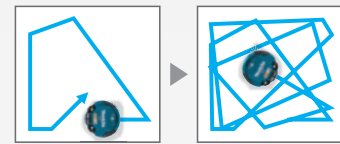

DRC300Z

OPPERVLAKTE  
TOT 600 m<sup>2</sup>

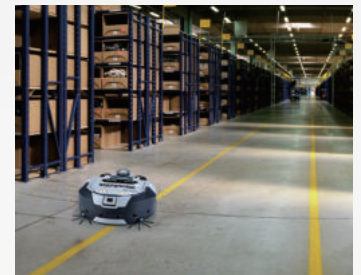

**DRC300**

- Kan ruimtes in kaart brengen door gebruik te maken van LiDAR module en beeldcamera. Tot 5 ruimtes kunnen in het geheugen bewaard worden. Dankzij de intelligente positiebepaling kan een ruimte efficiënter gereinigd worden en kan de machine ook automatisch terugkeren naar het beginpunt
- Verschillende sensoren voor obstakel- en grensdetectie
- Modi "alleen borstelen" of "stofzuigen + borstelen"
- Bediening op het toestel zelf, met de afstandsbediening of met de smartphone app (Wifi verbinding)
- Via de smartphone app kunnen de bewaarde kaarten weergegeven en geoptimaliseerd worden (bv. het definiëren van verboden zones) en kan ook schoonmaakstatus- en historiek gecontroleerd worden
- Werkt op één 18 V accu of twee in parallel. De accu's moeten uit het toestel verwijderd worden om op te laden.



MET CAMERA



**NIEUW**

	DRC200Z	DRC200PTJ	DRC300Z
Spanning	18 V (één of 2 in parallel)		
Capaciteit opvangbak	2,5 l	2,5 l	3,0 l
Max. registreerbare oppervlakte	-	-	10000 m <sup>2</sup>
Max. snelheid	0,3 m/s	0,3 m/s	0,3 m/s
Bijgeleverde accu's	-	2 x BL1850B	-
Gewicht	7,8 kg	7,8 kg	9,6 - 10,6 kg
Prijs in €	excl. btw		
	incl. btw		

ACCU STOFZUIGERS L-KLASSE LXT



DVC155LZX2



DVC863LZ



DVC867LZX4

DVC157LZX3

promo: gratis CL102DW bij DVC863LZ



	DVC150LZ	DVC155LZX2	DVC863LZ	DVC153LZ	DVC867LZX4	DVC157LZX3
Spanning	2 x 18 V / 230 V	2 x 18 V	2 x 18 V	2 x 18 V	2 x 18 V	2 x 18 V
Kuipvolume	15 l	15 l	8 l	15 l	8 l	15 l
Type	Nat & Droog	Nat & Droog	Droog	Droog	Droog	Droog
Filter	Textielfilter	Textielfilter	HEPA	HEPA	HEPA	HEPA
Max. debiet	2,1 / 3,6 m³/min	2,1 m³/min	2,1 m³/min	2,1 m³/min	2,4 m³/min	2,4 m³/min
Max. onderdruk	90 / 240 mbar	110 mbar	98 mbar	98 mbar	110 mbar	110 mbar
AWS	-	-	-	-	✓	✓
Gewicht	8,9 kg	7,9 kg	7,9 kg	7,9 kg	7,8 kg	8,0 kg
Prijs in €	excl. btw					
	incl. btw					

ACCU STOFZUIGERS L-KLASSE XGT



VC003GLZ

VC004GLZ

VC005GLZ



- Voeding met twee 40Vmax accu's in parallel.
- Hoge zuigkracht dankzij hoger vermogen en verbeterde koeling.
- Met telescopische steel (VC001G/VC003G/VC005G)
- Vloerborstel met laag profiel en verstelling voor harde vloer of tapijt (VC001G/VC003G/VC005G).
- VC005G: hoge wendbaarheid en stabiliteit door extra grote wielen achteraan.

Toepassing:

- VC001G / VC003G: voor schoonmaak, droog en nat gebruik.
- VC002G/VC004G: ideaal voor stofafzuiging van machines (met HEPA filter en AWS).
- VC005G: voor schoonmaak, droog gebruik.

	VC001GLZ	VC003GLZ	VC002GLZ01	VC004GLZ01	VC005GLZ
Spanning	36 V (40Vmax)	36 V (40Vmax)	36 V (40Vmax)	36 V (40Vmax)	36 V (40Vmax)
Type	Droog/Nat	Droog/Nat	Droog	Droog	Droog
Capaciteit	8 l	15 l	8 l	15 l	8 l
Max. debiet	3,2 m³/min	3,2 m³/min	1,8 m³/min	1,8 m³/min	2,8 m³/min
Max. onderdruk	230 mbar	230 mbar	180 mbar	230 mbar	230 mbar
Filter	Textielfilter	Textielfilter	HEPA	HEPA	Textielfilter
Gewicht	8,1 - 10 kg	8,1 - 10 kg	8,3 - 10,2 kg	8,3 - 10,2 kg	7,9 - 9,8 kg
Bijgeleverde accu's	-	-	-	-	-
Prijs in €	excl. btw				
	incl. btw				

**WAT BETEKEN L-, M- OF H-KLASSE?**

Stofzuigers voor professioneel gebruik worden volgens EN60335-2-69 ingedeeld in risicoklassen:

- L-klasse** (Low risk) stofzuigers mogen gebruikt worden voor alle stof waarvan de toelaatbare blootstellingswaarde groter is dan 1 mg/m<sup>3</sup>. Deze stofzuigers laten minder dan 1 % van het opgezogen stof door.
- M-klasse** (Medium risk) stofzuigers mogen gebruikt worden voor alle stof waarvan de toelaatbare blootstellingswaarde groter is dan 0,1 mg/m<sup>3</sup>. Deze stofzuigers laten minder dan 0,1 % van het opgezogen stof door en voldoen bovendien aan een aantal bijkomende eisen, waaronder permanente debietcontrole en stofarme lediging.
- H-klasse** stofzuigers (High risk) moeten gebruikt worden voor stoffen waarvan de max. blootstellingswaarde < 0,1 mg/m<sup>3</sup> bedraagt. Deze stofzuigers laten minder dan 0,005 % van het opgezogen stof door en moeten ook voldoen aan een aantal bijkomende eisen, zoals permanente debietcontrole en stofarme lediging.

Opgelet: stofzuigers zonder aanduiding van de stofklasse volgens EN60335-2-69 bieden geen enkele garantie op het vlak van persoonlijke veiligheid en zijn derhalve niet geschikt voor professioneel gebruik.

**INCLUSIEF  
1 SET ACCESSOIRES**



VC2012L

**STOFZUIGERS L-KLASSE**

**INCLUSIEF  
1 SET ACCESSOIRES**

Klasse L  
VC2512L



Klasse L  
VC2000L



Klasse L  
VC3011L



Klasse L  
VC3012L



**STOFZUIGERS L-, M- EN H-KLASSE**

**INCLUSIEF  
1 SET ACCESSOIRES**

Klasse L  
VC2510LX1



Klasse L  
VC3210LX1



Klasse M  
VC3211MX1



Klasse H  
VC3211HX1



Automatische filterreininging  
zonder zuigkracht-  
onderbreking.

Automatische filterreininging  
zonder zuigkracht-  
onderbreking.

**STOFZUIGERS L- EN M-KLASSE**

**INCLUSIEF  
1 SET ACCESSOIRES**

Klasse M  
VC2211MX1



Automatische filterreininging  
zonder zuigkracht-  
onderbreking.

Klasse L  
VC4210LX



Automatische filterreininging  
zonder zuigkracht-  
onderbreking.

Klasse M  
VC4210MX



Automatische filterreininging  
zonder zuigkracht-  
onderbreking.



	VC2000L	VC2012L	VC2512L	VC3011L	VC3012L	VC3012M	VC2211MX1
Nominaal vermogen	1000 W	1100 W	1100 W	1000 W	1200 W	1200 W	1050 W
Max. debiet	3,6 m <sup>3</sup> /min	3,6 m <sup>3</sup> /min	3,6 m <sup>3</sup> /min	3,6 m <sup>3</sup> /min	3,7 m <sup>3</sup> /min	3,7 m <sup>3</sup> /min	3,5 m <sup>3</sup> /min
Max. onderdruk	210 mbar	210 mbar	210 mbar	210 mbar	230 mbar	230 mbar	220 mbar
Bruto kuipvolume	20 l	19 l	23 l	30 l	30 l	30 l	22 l
Gewicht	7,5 kg	7,3 kg	6,3 kg	10,5 kg	10 kg	10 kg	16,3 kg
Prijs in €	excl. btw						
	incl. btw						

	VC2510LX1	VC3210LX1	VC3211MX1	VC3211HX1	VC4210LX	VC4210MX
Nominaal vermogen	1050 W	1050 W	1050 W	1050 W	1200 W	1200 W
Max. debiet	3,5 m <sup>3</sup> /min	3,5 m <sup>3</sup> /min	3,5 m <sup>3</sup> /min	3,5 m <sup>3</sup> /min	4,5 m <sup>3</sup> /min	4,5 m <sup>3</sup> /min
Max. onderdruk	220 mbar	220 mbar	220 mbar	220 mbar	250 mbar	250 mbar
Bruto kuipvolume	32 l	40 l	40 l	40 l	42 l	42 l
Gewicht	10,5 kg	14,5 kg	16,9 kg	16,9 kg	15 kg	15 kg
Prijs in €	excl. btw					
	incl. btw					

BOORHAMERS SDS-PLUS 2 FUNCTIES



	HR2600	HR1841FJ	HR2800
Nominaal vermogen	800 W	470 W	800 W
Slagenergie	2,4 J	1,4 J	2,8 J
Max. Ø beton	26 mm	18 mm	28 mm
AVT	-	✓	-
Vibratieniveau hamerboren	15,5 m/s <sup>2</sup>	7,5 m/s <sup>2</sup>	20 m/s <sup>2</sup>
Gewicht	2,8 kg	2,5 kg	3,4 kg
Prijs in €	excl. btw		
	incl. btw		

COMBIHAMERS SDS-PLUS 3 FUNCTIES



Inclusief automatische boorkop bij HR2630X7

Inclusief Boor- en beitelset 17 stuks bij HR2470FTP, HR2630TX12 & HR2631FT12 t.w.v.

	HR2470	HR2470FTP	HR2630X7	HR2630TX12	HR2631FT12	HR2811FT
Nominaal vermogen	780 W	780 W	800 W	800 W	800 W	800 W
Slagenergie	2,4 J	2,4 J	2,4 J	2,4 J	2,4 J	2,9 J
Max. Ø beton	24 mm	24 mm	26 mm	26 mm	26 mm	28 mm
AVT	-	-	-	-	✓	-
Vibratieniveau hamerboren	15,5 m/s <sup>2</sup>	15,5 m/s <sup>2</sup>	15 m/s <sup>2</sup>	15 m/s <sup>2</sup>	11,5 m/s <sup>2</sup>	15 m/s <sup>2</sup>
Gewicht	3,0 kg	3,0 kg	3,0 kg	2,9 kg	3,0 kg	3,6 kg
Prijs in €	excl. btw					
	incl. btw					

COMBIHAMERS SDS-PLUS MET STOF AFZUIGING



Inclusief boor- en beitelset 17 stuks bij HR2651TX12 t.w.v.

Inclusief stofafzuigingsunit DX11 bij HR3012FCWJ

	HR2651TX12	HR3012FCWJ
Nominaal vermogen	800 W	1050 W
Slagenergie	2,2 J	3,9 J
Max. Ø beton	26 mm	30 mm
AVT	✓	✓
Vibratieniveau hamerboren	11,5 m/s <sup>2</sup>	9,5 m/s <sup>2</sup>
Gewicht	4,2 kg	4,4 kg
Prijs in €	excl. btw	
	incl. btw	

COMBIHAMERS SDS-PLUS



HR3210FCT

**INCLUSIEF**  
1 automatische  
boorkop (194568-7)  
bij HR3210FCT



HR3210FCT:  
met anti-vibratie  
handgreep

	HR3200C	HR3210FCT
Nominaal vermogen	850 W	850 W
Slagenergie	5,1 J	4,9 J
Max. Ø beton	32 mm	32 mm
AVT	-	✓
Vibratieniveau hamerboren	18 m/s <sup>2</sup>	10 m/s <sup>2</sup>
Gewicht	4,8 kg	5,4 kg
Prijs in €	excl. btw	
	incl. btw	

COMBIHAMERS SDS-MAX



Inclusief  
Boor- en beitelhamer  
HR2470FTP bij HR4013C,  
HR4511C en HR5212C  
t.w.v.



HR4013CV

**CV-modellen**  
inclusief  
stofafzuigset

	HR3541FCX	HR4013C	HR4013CV	HR4511C	HR4511CV	HR5212C	HR5212CV
Nominaal vermogen	850 W	1100 W	1100 W	1350 W	1350 W	1500 W	1500 W
Slagenergie	5,7 J	8,0 J	8,0 J	9,4 J	9,4 J	18,9 J	18,9 J
Max Ø beton	35 mm	40 mm	40 mm	45 mm	45 mm	52 mm	52 mm
AVT	✓	✓	✓	✓	✓	✓	✓
Vibratieniveau hamerboren	11 m/s <sup>2</sup>	5,0 m/s <sup>2</sup>	5,0 m/s <sup>2</sup>	7,5 m/s <sup>2</sup>	7,5 m/s <sup>2</sup>	12,5 m/s <sup>2</sup>	12,5 m/s <sup>2</sup>
Gewicht	5,6 kg	6,8 kg	6,8 kg	8,8 kg	8,8 kg	12,1 kg	12,1 kg
Prijs in €	excl. btw						
	incl. btw						

STOFAFZUIGSET VOOR BOOR-EN BREEKHAMERS



		199142-6	195866-2	196858-4
		HR4013C	HR4511C	HR5212C
Prijs in €	excl. btw			
	incl. btw			

BIKHAMERS SDS-PLUS



HK1820

	HK0500	HK1820
Nominaal vermogen	550 W	550 W
Slagfrequentie	2000-3500 /min	0-3200 /min
Slagenergie	1,8 J	3,1 J
AVT	-	-
Triaxiale vibratiewaarde (ah)	9,5 m/s <sup>2</sup>	10 m/s <sup>2</sup>
Gewicht	3,2 kg	3,4 kg
Prijs in €	excl. btw	
	incl. btw	

BREEKHAMERS SDS-MAX



HM1213C



**PROMO** Beitelset E-04927 t.w.v. gratis bij HM0871C

Wist u dat u tijdens de garantieperiode recht hebt op één gratis onderhoudsbeurt? Ontdek er meer over op [www.makita.be](http://www.makita.be)

**AVT**  
ANTI VIBRATION TECHNOLOGY

**SOFT NO LOAD**



HM0871C



HM121C

	HM0870C	HM0871C	HM0871CV	HM1101C	HM1101CV
Nominaal vermogen	1100 W	1100 W	1100 W	1300 W	1300 W
Slagfrequentie	1100-2650 /min	1100-2650 /min	1100-2650 /min	1100-2600 /min	1100-2600 /min
Slagenergie	7,6 J	8,1 J	8,1 J	11,5 J	11,5 J
AVT	-	✓	✓	-	-
Triax. vibratie beitelen (ah)	11,5 m/s <sup>2</sup>	8 m/s <sup>2</sup>	8 m/s <sup>2</sup>	13,5 m/s <sup>2</sup>	13,5 m/s <sup>2</sup>
Gewicht	5,1 kg	5,8 kg	5,8 kg	7 kg	7 kg
Prijs in €	excl. btw				
	incl. btw				

**CV-modellen**  
inclusief  
stofafzuigset

	HM1111C	HM1111CV	HM1203C	HM1213C	HM1214C
Nominaal vermogen	1300 W	1300 W	1510 W	1510 W	1510 W
Slagfrequentie	1100-2600 /min	1100-2600 /min	950-1900 /min	950-1900 /min	950-1900 /min
Slagenergie	11,2 J	11,2 J	19,1 J	18,6 J	19,9 J
AVT	✓	✓	-	✓	✓
Triax. vibratie beitelen (ah)	8 m/s <sup>2</sup>	8 m/s <sup>2</sup>	15,5 m/s <sup>2</sup>	7 m/s <sup>2</sup>	8 m/s <sup>2</sup>
Gewicht	7,7 kg	7,7 kg	9,7 kg	10,8 kg	12,3 kg
Prijs in €	excl. btw				
	incl. btw				



STOFAFZUIGING BREEKHAMERS



199144-2



197168-2

		<b>199144-2</b>	<b>197168-2</b>
GESCHIKT VOOR		Breekhamers SDS-Max	HM1810 / HM1812 / HM1317C
Prijs in €	excl. btw		
	incl. btw		

**SOFT  
NO LOAD**

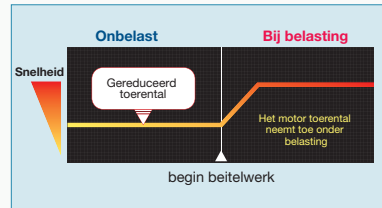

Reduceert automatisch het toerental van de machine om ongewenste trillingen verder te reduceren.

BREEKHAMERS MET ZESKANTOPNAME



**SOFT  
NO LOAD** **AVT**  
ANTI VIBRATION TECHNOLOGY

**HM1511/HM1512:**  
Slagenergie  
48,9 J



HM1812

GRATIS  
trolley  
ter waarde  
van  
bij HM1812



**HM1812:**  
Slagenergie 72,8 J



HM1511

**HM1511 / HM1512 :**  
Uitzonderlijk laag trillings-  
niveau door anti-vibratie behuizing,  
actieve trillingsdemping en soft-  
no-load



	HM1317C	HM1511	HM1512	HM1812
Nominaal vermogen	1510 W	1850 W	1850 W	2000 W
Slagfrequentie	730-1450 /min	1300 /min	1300 /min	870 /min
Slagenergie	25 J	48,9 J	48,9 J	72,8 J
AVT	✓	✓	✓	✓
Triax. vibratie beitelen (ah)	8,5 m/s <sup>2</sup>	6,5 m/s <sup>2</sup>	6,5 m/s <sup>2</sup>	6,5 m/s <sup>2</sup>
Opname hex.	30 mm	30 mm	28,6 mm	28,6 mm
Gewicht	17 kg	19,2 kg	20,4 kg	31,3 kg
Prijs in €	excl. btw			
	incl. btw			

KLOPBOORMACHINES



HP2071FJ

	HP1631KSP	HP2051FHJ	HP2071FJ
Nominaal vermogen	710 W	720 W	1010 W
Toerental	0-3200 t.p.m.	0-2900 t.p.m.	0-2900 t.p.m.
Ø Max. staal	13 mm	13 mm	18 mm
Ø Max. hout	30 mm	40 mm	40 mm
Ø Max. steen	16 mm	20 mm	20 mm
Boorkop	1,5-13 mm	1,5-13 mm	1,5-13 mm
Makpac	-	✓	✓
Gewicht	2 kg	2,5 kg	2,6 kg
Prijs in €	excl. btw		
	incl. btw		

BOORMACHINES



DP4011

DP4011  
Met 2 snelheden

	DP2011	DP4011	DP4003
Nominaal vermogen	370 W	720 W	750 W
Toerental	0-4200 t.p.m.	0-2900 t.p.m.	0-700 t.p.m.
Ø Max. staal	6,5 mm	13 mm	13 mm
Ø Max. hout	15 mm	40 mm	38 mm
Boorkop	0,8-6,5 mm	1,5-13 mm	1,5-13 mm
Gewicht	1,1 kg	2,3 kg	2,4 kg
Prijs in €	excl. btw		
	incl. btw		

HAAKSE BOORMACHINES



DA3010FJ

DA3011FJ



	DA3010FJ	DA3011FJ
Nominaal vermogen	450 W	450 W
Toerental	0-2400 t.p.m.	0-2400 t.p.m.
Ø Max. staal	10 mm	10 mm
Ø Max. hout	25 mm	25 mm
Boorkop	1-10 mm	1-10 mm
Gewicht	1,6 kg	1,6 kg
Prijs in €	excl. btw	
	incl. btw	

KLOPBOORMACHINE MET SLIPKOPPELING



8406

Nominaal vermogen	850 W
Toerental	0 - 1500 t.p.m.
Ø Max. staal	13 mm
Max. slagfrequentie	22500 /min
Gewicht	3,7 kg
Prijs in €	excl. btw
	incl. btw

KERNBOORMACHINE MET MAGNEETVOET



	HB350	HB500
Nominaal vermogen	1050 W	1150 W
Toerental onbelast 1	450 t.p.m.	350 t.p.m.
Toerental onbelast 2	850 t.p.m.	650 t.p.m.
Ø Max. staal	35 mm	50 mm
Klemkracht magneetvoet	8000 N	9300 N
Opname	3/4" WELDON	3/4" WELDON
Gewicht	11,5 kg	18,5 kg
Prijs in €	excl. btw	
	incl. btw	

DIAMANTKERNBOORMACHINES



DBM131W

DBM131W / DBM230W  
Geleverd met boorstandaard



	DBM131	DBM131W	DBM230W
Nominaal vermogen	1700 W	1700 W	2500 W
Toerental onbelast 1	1100 t.p.m.	1100 t.p.m.	390 t.p.m.
Toerental onbelast 2	2300 t.p.m.	2300 t.p.m.	1040 t.p.m.
Toerental onbelast 3	-	-	1700 t.p.m.
Ø Max. beton	132 mm	132 mm	230 mm
Gewicht	6,1 kg	6,1 kg	6,9 kg
Prijs in €	excl. btw		
	incl. btw		

MENGRS



UT1600

	UT1400	UT1401	UT1600
Nominaal vermogen	1300 W	1300 W	1800 W
Toerental onbelast 1	0-900 t.p.m.	0-400 t.p.m.	0-440 t.p.m.
Toerental onbelast 2	-	0-730 t.p.m.	0-970 t.p.m.
Toerental belast max.	0-580 t.p.m.	0-450 t.p.m.	0-580 t.p.m.
Schroefdraad spindel	M14	M14	M14
Gewicht	5,2 kg	5,5 kg	7,1 kg
Prijs in €	excl. btw		
	incl. btw		

BOORMACHINE / MENGER



DS4012

Nominaal vermogen	750 W
Toerental	600 t.p.m.
Ø Max. staal	13 mm
Ø Max. hout	36 mm
Boorkop	2-13 mm
Gewicht	2,8 kg
Prijs in €	excl. btw
	incl. btw

SCHROEFAUTOMATEN



6843J

	6844	6843J
Nominaal vermogen	470 W	470 W
Toerental	3000 t.p.m.	6000 t.p.m.
Ø gipsplaatschroef	3,5 - 4,0 mm	3,5 - 4,0 mm
Schroeflengte	45-75 mm	25-55 mm
Verpakking	Koffer	Makpac
Gewicht	2 kg	2 kg
Prijs in €	excl. btw	
	incl. btw	

SCHROEFMACHINES VOOR GIPSPLAAT



FS2500K: met 1/4"  
Hex bitopname



FS2500

FS2701K:  
met koppeling  
(6 stappen)



FS2701K



schroeflintadapter  
191L24-0

	FS2300K	FS2500K	FS2701K	FS4000JX2	FS6300RJX2
Nominaal vermogen	570 W	570 W	570 W	570 W	570 W
Toerental	0-2500 t.p.m	0-2500 t.p.m	0-2500 t.p.m	0-4000 t.p.m.	0-6000 t.p.m.
Ø gipsplaatschroef	5 mm	5 mm	5 mm	5 mm	5 mm
Incl. schroeflintadapter	-	-	-	✓	✓
Gewicht	1,7 kg	1,6 kg	1,7 kg	1,3 kg	1,4 kg
Prijs in €	excl. btw				
	incl. btw				

HETELUCHTPISTOLEN



HG6531CK



HG5030K

	HG5030K	HG6031VK	HG6531CK
Vermogen	1600 W	1800 W	2000 W
Temperatuurbereik	350-500 °C	50-600 °C	50-650 °C
Temperatuurinstelling	2 niveaus	9 niveaus	Elektronisch in stappen van 5°C
Debiet	300 / 500 l/min	250 / 500 l/min	200 / 550 l/min
Gewicht	0,56 kg	0,67 kg	0,71 kg
Prijs in €	excl. btw		
	incl. btw		

SLAGMOERSLEUTELS



TW0350J

TW0200J  
TW0350J  
6906J

	TW0200J	TW0350J	6906J	TW1000
Nominaal vermogen	380 W	400 W	650 W	1300 W
Max. koppel	200 Nm	350 Nm	588 Nm	1000 Nm
Bitopname	1/2" vierkant	1/2" vierkant	3/4" vierkant	1" vierkant
Gewicht	2,2 kg	3 kg	5,6 kg	8,6 kg
Prijs in €	excl. btw			
	incl. btw			

KNABELSCHAREN



JN3201J

	JN1601	JN3201J
Nominaal vermogen	550 W	710 W
Max. dikte staal	1,6 mm	3,2 mm
Gewicht	1,6 kg	3,4 kg
Prijs in €	excl. btw	
	incl. btw	

PLAATSCHAREN



JS1602J

	JS1601J	JS1602J	JS3201J
Nominaal vermogen	380 W	380 W	710 W
Aantal zaagbewegingen	4500 /min	4000 /min	1600 /min
Max. dikte staal	1,6 mm	1,6 mm	3,2 mm
Gewicht	1,4 kg	1,6 kg	3,4 kg
Prijs in €	excl. btw		
	incl. btw		

METAALCIRKELZAAG



4131

	4131
Nominaal vermogen	1100 W
Toerental	3500 t.p.m.
Zaagdiepte (90°)	63 mm
Ø Zaagblad	185 mm
Gewicht	5,1 kg
Prijs in €	excl. btw
	incl. btw

GROEFFREES



Voor aluminium /  
composiet platen

	CA5000XJ
Nominaal vermogen	1300 W
Toerental	2200-6400 t.p.m.
Ø Zaagblad	118 mm
Gewicht	5,1 kg
Prijs in €	excl. btw
	incl. btw

COMFORTABEL WERKEN MET SUPER JOINT SYSTEM II

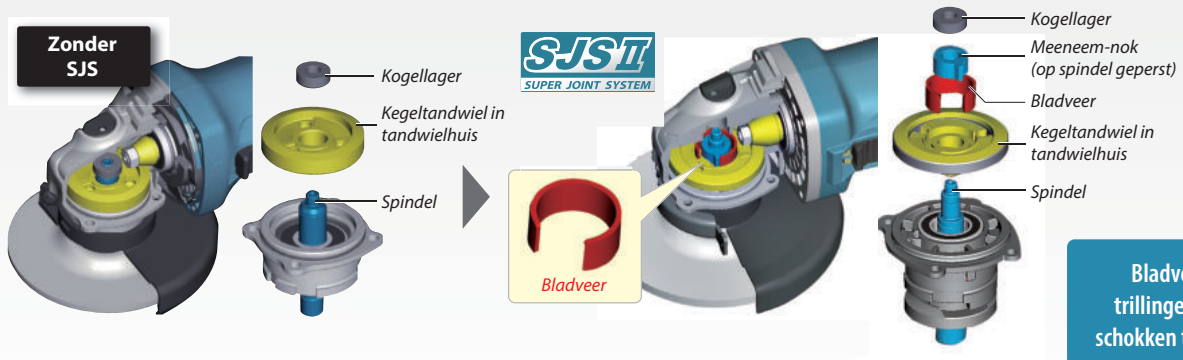

HAAKSE SLIJPER 125 MM



GA5034



	GA5034	GA5030RK	GA5030RSP2
Nominaal vermogen	720 W	720 W	720 W
Toerental	11000 t.p.m.	11000 t.p.m.	11000 t.p.m.
Ø schijf	125 mm	125 mm	125 mm
Dodemansschakelaar	✓	-	-
Gewicht	1,9 kg	1,8 kg	1,8 kg
Prijs in €	excl. btw		
	incl. btw		

HAAKSE SLIJPER 115 MM



GA4530RK

		GA4530RK
Nominaal vermogen		720 W
Toerental		11000 t.p.m.
Ø schijf		115 mm
Gewicht		1,8 kg
Prijs in €	excl. btw	
	incl. btw	

HAAKSE SLIJPER 125 MM

9558HNRGK3



125 MM

	9558HNRGZ	9558PBGY	9558HNRGK3
Nominaal vermogen	840 W	840 W	840 W
Toerental	11000 t.p.m.	11000 t.p.m.	11000 t.p.m.
Ø schijf	125 mm	125 mm	125 mm
Dodemansschakelaar	-	✓	-
Gewicht	2,1 kg	2,1 kg	2,1 kg
Prijs in €	excl. btw		
	incl. btw		

HAAKSE SLIJPER 125 MM X-LOCK



Snel en veilig schijven bevestigen via een kliksysteem.



GA5080RX03

GA5080RX03

Nominaal vermogen	1400 W
Toerental	12000 t.p.m.
Ø schijf	125 mm
Verpakking	Makpac
Gewicht	2,5 – 3,6 kg
Prijs in €	excl. btw
	incl. btw

HAAKSE SLIJERS 125 MM



GA5041RZ

GA5040CJD1



GA5041CT01 met mechanische motorrem, instelbaar toerental, Ezynt & AVT-grip

SA5040C Traagdraaiend

	GA5040RZ	GA5040RKDJ	GA5040C	GA5040CJD	GA5040CJD1	GA5041RZ	GA5041CT01	SA5040C
Nominaal vermogen	1100 W	1100 W	1400 W	1400 W	1400 W	1100 W	1400 W	1400 W
Toerental	11000 t.p.m.	11000 t.p.m.	2800-11000 t.p.m.	2800-11000 t.p.m.	2800-11000 t.p.m.	11000 t.p.m.	2700-11000 t.p.m.	2000-7800 t.p.m.
Heropstartbeveiliging	✓	✓	✓	✓	✓	✓	✓	✓
Mechanische rem	-	-	-	-	-	✓	✓	-
Verpakking	Karton	Makpac	Karton	Makpac	Makpac	Karton	Karton	Karton
Gewicht	2,4 kg	2,4 kg	2,4 kg	2,4 kg	2,7 kg	2,4 kg	2,7 kg	2,2 kg
Meegeleverde accessoires		2 x diamantschijf		2 x diamantschijf	1 x diamantschijf + beschermkap stofafzuiging		AVT-greep + Ezynt sluitmoer	
Prijs in €	excl. btw							
	incl. btw							

HAAKSE SLIJERS 125 MM / 150 MM



9565PCV01

9565PCV01 & 9566PCV01: Antivibratiehandgreep en dodemansschakelaar.



GA5050R: grote lepelschakelaar + gereedschapsloze beschermkap

	GA5050R	9565CRX1	9565PCV01	9566PCV01	GA6040C
Nominaal vermogen	1300 W	1400 W	1400 W	1400 W	1400 W
Toerental	11000 t.p.m.	11000 t.p.m.	2800-11500 t.p.m.	4000-10000 t.p.m.	4000-9000 t.p.m.
SJS	-	✓	✓	✓	✓
Ø schijf	125 mm	125 mm	125 mm	150 mm	150 mm
Dodemansschakelaar	✓	-	✓	✓	-
Gewicht	2,5 kg	2,6 kg	2,6 kg	2,7 kg	2,6 kg
Prijs in €	excl. btw				
	incl. btw				

HAAKSE SLIJERS 125 MM



GA5021C

GA5021CYX1: Inclusief antivibratiegreep en Ezynt sluitmoer

	GA5021C	GA5021CY	GA5021CYX1
Nominaal vermogen	1450 W	1450 W	1450 W
Toerental	10000 t.p.m.	10000 t.p.m.	10000 t.p.m.
Ø schijf	125 mm	125 mm	125 mm
Dodemansschakelaar	-	✓	✓
Gewicht	3 kg	3 kg	3 kg
Prijs in €	excl. btw		
	incl. btw		

10x Doorslijpschijven in blik



Best. Nr.	Ø (mm)	Dikte (mm)	Ø asgat (mm)	Prijs	
				excl. btw	incl. btw
D-18770-10	125	1,2	22,23		

HAAKSE SLIJPERS 180 MM



GA7082

GA7070X1

	GA7050	GA7060	GA7070X1	GA7082	GA7070YX1
Nominaal vermogen	2000 W	2200 W	2800 W	2800 W	2800 W
Toerental	8500 t.p.m.	8500 t.p.m.	8500 t.p.m.	8500 t.p.m.	8500 t.p.m.
Dodemansschakelaar	✓	✓	-	-	✓
Draaibare achterhand-greep	-	-	✓	-	✓
Mechanische rem	-	-	✓	-	✓
Gewicht	4,5 kg	5,3 kg	6,2 - 6,7 kg	6,0 kg	6,1 - 6,6 kg
Prijs in €	excl. btw				
	incl. btw				

**NIEUW**

**NIEUW**

HAAKSE SLIJPERS 230 MM



GA9012C

GA9061R

GA9082



GA9060KD

Incl. diamantschijf

	GA9050	GA9060	GA9060KD	GA9061R	GA9012C	GA9082
Nominaal vermogen	2000 W	2200 W	2200 W	2200 W	1800 W	2700 W
Toerental	6600 t.p.m.	6600 t.p.m.	6600 t.p.m.	6600 t.p.m.	6000 t.p.m.	6600 t.p.m.
Soft start	-	-	-	✓	✓	✓
Dodemansschakelaar	✓	✓	✓	-	-	-
Draaibare achterhand-greep	-	-	-	-	-	-
Heropstartbeveiliging	-	-	-	✓	✓	-
Gewicht	4,7 kg	5,6 kg	5,6 kg	5,7 kg	4,5 kg	6,1 kg
Prijs in €	excl. btw					
	incl. btw					

**NIEUW**

HAAKSE SLIJPERS 230 MM



GA9040RF01

GA9030SF01

GA9070YX1

GA9071YX1:  
Met gesloten handgreep

	GA9030SF01	GA9030RF01	GA9040SF01	GA9040RF01	GA9080X1	GA9070X1	GA9071X1	GA9070YX1	GA9071YX1
Nominaal vermogen	2400 W	2400 W	2600 W	2600 W	2700 W	2800 W	2800 W	2800 W	2800 W
Toerental	6600 t.p.m.	6600 t.p.m.	6600 t.p.m.	6600 t.p.m.	6600 t.p.m.	6600 t.p.m.	6600 t.p.m.	6600 t.p.m.	6600 t.p.m.
Dodemansschakelaar	✓	-	✓	-	-	-	-	✓	✓
Draaibare achterhandgreep	✓	✓	✓	✓	✓	✓	✓	✓	✓
Antivibratie zijhandgreep	✓	✓	✓	✓	-	✓	✓	✓	✓
Soft start	✓	✓	✓	✓	✓	✓	✓	✓	✓
Heropstartbeveiliging	-	✓	-	✓	✓	✓	✓	✓	✓
Mechanische rem	-	-	-	-	-	✓	✓	✓	✓
Gewicht	6,3 kg	6,5 kg	6,7 kg	6,9 kg	6,4 kg	6,3 kg	6,4 kg	6,3 - 8,5 kg	6,3 - 8,5 kg
Prijs in €	excl. btw								
	incl. btw								

**NIEUW**

**NIEUW**

STEMPELSLIJERS



GS5000



GD0811C



GD0810C



GD0603

	GD0600	GD0603	GD0800C	GD0801C	GD0810C	GD0811C	GS5000
Nominaal vermogen	400 W	240 W	750 W	750 W	750 W	750 W	750 W
Toerental	25000 t.p.m.	28000 t.p.m.	7000-28000 t.p.m.	7000-28000 t.p.m.	1800-7000 t.p.m.	1800-7000 t.p.m.	5600 t.p.m.
∅ spantang - bereik	6 mm	6 mm	6-8 mm	6-8 mm	6-8 mm	6-8 mm	20 mm
∅ spantang - inbegrepen	6 mm	6 mm	6 mm	6 mm	6 mm	6 mm	20 mm
Lepelschakelaar	✓	-	-	✓	-	✓	-
Dodemansschakelaar	-	-	-	✓	-	✓	✓
Gewicht	1,7 kg	0,97 kg	1,7 kg	1,7 kg	1,7 kg	2,0 kg	5,0 kg
Prijs in €	excl. btw						
	incl. btw						

COMBOPACK SLIJERS



9558HNRG

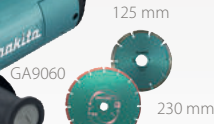

DK0047GX1 DK0046X1

Haakse slijper 230 mm	GA9060	GA9061R
Haakse slijper 125 mm	9558HNRG	GA5040RZ
Diamantschijf	2 x Diamak DS	2 x Diamak DS
Synthetische koffer	✓	✓
Prijs in €	excl. btw	
	incl. btw	

COMBOPACK KLOPBOORMACHINE + HAAKSE SLIJPER



DK0050X1

Klopboormachine 710 W	HP1631
Haakse slijper 125 mm	GA5030R
Borensset	D-08660
Synthetische koffer	✓
Prijs in €	excl. btw
	incl. btw

COMBOPACK HAAKSE SLIJPER + STOFZUIGING



inclusief  
stofafzuiging 196845-3  
t.w.v.



DK9525

Haakse slijper 125 mm 1400 W	9565CRX1
Stofzuiger	VC2510LX1
Prijs in €	excl. btw
	incl. btw

COMBOPACK SCHUURMACHINE + STOFZUIGER



DK6525

Schuurmachine	BO6050J
Stofzuiger	VC2510LX1
Prijs in €	excl. btw
	incl. btw



METAALAFKORTMACHINES

LC1230N

- Inclusief HM zaagblad
- verstekhoek instelbaar op 45°



LW1400X



LC1230N

LW1400X LC1230N

Nominaal vermogen	2200 W	1750 W
Type schijf	doorslijpschijf	zaagblad
Toerental	3800 t.p.m.	1300 t.p.m.
Zaagdiepte (90°)	115 mm	100 mm
Ø Zaagblad	355 mm	305 mm
Gewicht	17,2 kg	19,3 kg
Prijs in €	excl. btw	
	incl. btw	

BETONSCHAVEN



PC5001C  
Geleverd met komschijf B-12289



PC5010C

PC50001C

PC5010C PC5001C

Nominaal vermogen	1400 W	1400 W
Ø schijf	125 mm	125 mm
Gewicht	2,5 kg	5,1 kg
Prijs in €	excl. btw	
	incl. btw	

PC5010C:  
Instelbaar toerental

MUURFREZEN



SG1251J



SG181

SG1251J SG150 SG181

Nominaal vermogen	1400 W	1800 W	2150 W
Max. slijpdiepte	30 mm	45 mm	60 mm
Sleufbreedte	6-30 mm	7-35 mm	7-43 mm
Ø schijf	125 mm	150 mm	180 mm
Gewicht	4,4 kg	5,7 kg	6 kg
Prijs in €	excl. btw		
	incl. btw		

DIAMANTZAAG



4114S

Nominaal vermogen	2400 W
Max. slijpdiepte	125 mm
Ø schijf	350 mm
Ø asgat	25,4 mm
Gewicht	10,8 kg
Prijs in €	excl. btw
	incl. btw

DIAMANTZAAG



4100KB



Nominaal vermogen	1400 W
Zaagdiepte (90°)	40 mm
Ø Zaagblad	125 mm
Gewicht	3,0 kg
Prijs in €	excl. btw
	incl. btw

MOTORDOORSLIJPERS



	EK6100	EK7301WS	EK7651H	EK8100WS
Motor	2-takt	2-takt	4-takt	2-takt
Cilinderinhoud	60,7 cc	72,6 cc	75,6 cc	80,7 cc
Vermogen	3,2 kW/4,3 pk	3,8 kW/5,2 pk	3,0 kW/4,1 pk	4,2 kW/5,7 pk
Maximaal nettokoppel	3,9 Nm	4,3 Nm	4,6 Nm	5,0 Nm
Ø schijf	300 mm	350 mm	350 mm	400 mm
Decompressieklep	-	✓	✓	✓
Gewicht	8,5 kg	10 kg	12,9 kg	10,6 kg
Prijs in €	excl. btw			
	incl. btw			

DIAMANTSCHIJVEN

	Artikel	Ø	Dikte	Hoogte segment	Ø asgat	Reductiering		
<b>Quasar</b>	 B-17588	300 mm	3,0 mm	12 mm	25,4 mm	20 mm		
	B-13465	350 mm	3,0 mm	12 mm	25,4 mm	20 mm		
	B-13471	400 mm	3,0 mm	12 mm	25,4 mm	20 mm		
<b>Comet</b>	 B-17619	300 mm	3,0 mm	10 mm	25,4 mm	20 mm		
	B-13552	350 mm	3,0 mm	10 mm	25,4 mm	20 mm		
	B-13568	400 mm	3,0 mm	10 mm	25,4 mm	20 mm		
<b>Asfalt</b>	 B-13275	350 mm	3,2 mm	10 mm	25,4 mm	20 mm		
	B-42905	400 mm	3,2 mm	10 mm	25,4 mm	20 mm		

	Artikel	Ø extern	Ø intern	Dikte		
<b>Reductieringen</b>	 257199-4	22,23 mm	20,00 mm	3,0 mm		
	197318-9	25,4 mm	20,00 mm	5 mm		

SLIJPMOLENS



GB801

	GB602W	GB801
Nominaal vermogen	250 W	550 W
Toerental	2850 t.p.m.	2850 t.p.m.
Ø Slijpsteen	150 mm	205 mm
Gewicht	9 kg	19,8 kg
Prijs in €	excl. btw	
	incl. btw	

LINTZAAGMACHINE



B-42581  
Schuurbanden 20 x 2240 mm  
Rood • Korrel 80

B-42597  
Schuurbanden 20 x 2240 mm  
Rood • Korrel 120

JM21000330  
Adapterset voor schuurbanden

	LB1200F
Nominaal vermogen	900 W
Breedte zaaglint	6-16 mm
Gewicht	81,2 kg
Prijs in €	excl. btw
	incl. btw

RECIPROZAGEN



JR3070CT

	JR3051TK	JR3061T	JR3070CT
Nominaal vermogen	1200 W	1250 W	1510 W
Aantal zaagbewegingen	0-3000 /min	0-2800 /min	0-2800 /min
AVT	-	-	✓
Pendelinstelling	-	-	✓
Slaglengthe	30 mm	32 mm	32 mm
Vibratieniveau	19,5 m/s <sup>2</sup>	23,5 m/s <sup>2</sup>	8,5 m/s <sup>2</sup>
Gewicht	3,2 kg	4,4 kg	4,4 kg
Prijs in €	excl. btw		
	incl. btw		

LAMELLENFREES



Revolver diepte-instelling met 6 preselecties voor een snelle afstelling.

Aanslagplaat met tandheugelverstelling voor een snelle en precieze aanpassing aan de materiaaldikte.

Kantelbare voetplaat met handige vergrendelingshendel en automatische stops op 0°, 45° en 90°.

		PJ7000J
Nominaal vermogen		700 W
Toerental		11000 t.p.m.
Ø zaagblad		100 mm
Asgat		22 mm
Gewicht		2,5 kg
Prijs in €	excl. btw	
	incl. btw	

MULTITOOL



INCLUSIEF:  
Set van 9 accessoires,  
30 schuurvellen en 1 afzuigset



GEREEDSCHAPSLOZE  
ACCESSOIREWISSEL

		TM3010CX3J
Nominaal vermogen		320 W
Oscillatiefrequentie		6000-20000/min
Oscillatiehoek		3,2°
Gewicht		1,6 kg
Prijs in €	excl. btw	
	incl. btw	

VANDIKTEBANK



		2012NB
Nominaal vermogen		1650 W
Toerental		8500 t.p.m.
Breedte		304 mm
Max. doorlaathoogte		155 mm
Max. spaanafname		3 mm
Gewicht		28,1 kg
Prijs in €	excl. btw	
	incl. btw	

KETTINGFREESMACHINES



		7104L	7104L-30
Nominaal vermogen		1140 W	1140 W
Toerental		3200 t.p.m.	3200 t.p.m.
Kettingnelheid onbelast		5 m/s	5 m/s
Ketting		16,5 mm	30 mm
Gatbreedte		16,5-30 mm	30-45 mm
Gatlengthe		54-130 mm	54-130 mm
Gewicht		17,3 kg	17,3 kg
Prijs in €	excl. btw		
	incl. btw		

BOVENFREZEN



RP1111CJ



RP2302FC

		NIEUW	NIEUW		
		RP0900J	RP1111CJ	RP1802F	RP2302FC
Nominaal vermogen		900 W	1100 W	1850 W	2300 W
Toerental		27000 t.p.m.	8000 - 27500 t.p.m.	23000 t.p.m.	9000-22000 t.p.m.
Max. induikdiepte		35 mm	57 mm	70 mm	70 mm
Ø Spantang - bereik		6-8 mm	6-8 mm	6-12 mm	6-12 mm
Ø Spantang - inbegrepen		8 mm	8 mm	6, 8, 12 mm	6, 8, 12 mm
Verpakking		Makpac	Makpac	Karton	Karton
Gewicht		2,7 kg	3,3 kg	6,2 kg	6,1 kg
Prijs in €	excl. btw				
	incl. btw				

KANTENFREZEN



3711



3712

3712: Inclusief kantelbare zool

	3711	3712
Nominaal vermogen	530 W	530 W
Toerental	32000 t.p.m.	32000 t.p.m.
Max. induikdiepte	42 mm	42 mm
Spantang	6 mm	6 mm
Gewicht	1,5 kg	1,7 kg
Prijs in €	excl. btw	
	incl. btw	

BOVEN- EN KANTENFREES



4 MACHINES IN 1

- Rechte kantenrees
- Verstelbare kantenrees
- Kantenrees met verschoven spindel
- Bovenrees

Rechte kantenrees  
Regelbare freesdiepte van 0 tot 40 mm

Verstelbare kantenrees  
Hoekinstelling tussen -30° en 45°

Kantenrees met verschoven spindel om zo dicht mogelijk tegen een obstakel te werken

Bovenrees  
Diepteregeling per 1/10 van een mm van 0 tot 35 mm

RT0702CX3J

Nominaal vermogen	710 W
Toerental	10000-30000 t.p.m.
Max. induikdiepte	35 mm
Ø Spantang - bereik	6 mm, 8 mm
Ø Spantang - inbegrepen	6 mm
Gewicht	1,8 kg
Prijs in €	excl. btw
	incl. btw

SCHAVEN



KP0810CJ

1100

	KP0800J	KP0810J	KP0810CJ	1100	1911BJ	1806B	KP312S
Nominaal vermogen	620 W	850 W	1050 W	950 W	900 W	1200 W	2200 W
Toerental	17000 t.p.m.	16000 t.p.m.	12000 t.p.m.	16000 t.p.m.	16000 t.p.m.	18000 t.p.m.	12000 t.p.m.
Breedte	82 mm	82 mm	82 mm	82 mm	110 mm	170 mm	312 mm
Max. spaanafname	2,5 mm	4 mm	4 mm	3 mm	2 mm	2 mm	3,5 mm
Gewicht	2,6 kg	3,3 kg	3,4 kg	5,1 kg	4,3 kg	9,0 kg	18,4 kg
Prijs in €	excl. btw						
	incl. btw						

DECOUPEERZAGEN



4350FCTJ



4351FCTJ



JV0600J



4329K



	4326	4329K	JV0600J	4350FCTJ	4351FCTJ
Nominaal vermogen	450 W	450 W	650 W	720 W	720 W
Aantal zaagbewegingen	3100 /min	500-3100 /min	500-3100 /min	800-2800 /min	800-2800 /min
Max. capaciteit hout	65 mm	65 mm	90 mm	135 mm	135 mm
Makpac	-	-	✓	✓	✓
Gewicht	1,8 kg	1,9 kg	2,4 kg	2,6 kg	2,5 kg
Prijs in €	excl. btw				
	incl. btw				

COMBOPACK

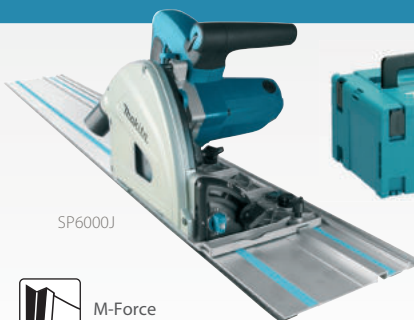

SP6000J



M-Force



4351FCTJ



MEU029J

Invalcirkelzaag	SP6000J
Decoupeerzaag	4351FCTJ
Geleiderail 1400 mm	194368-5
Extra cirkelzaagblad	B-32007
Decoupeerzaagbladen	5
Draagtas	B-57613
Prijs in €	excl. btw
	incl. btw

INVALCIRKELZAAG

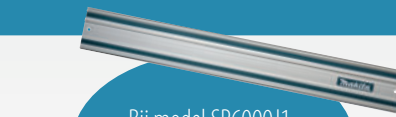

Bij model SP6000J1  
2 x geleiderail 1,4 m  
+ koppelstrips

	SP6000J	SP6000J1
Nominaal vermogen	1300 W	1300 W
Zaagdiepte (90°)	57 mm	57 mm
Zaagdiepte (45°)	40 mm	40 mm
Max. zaagdiepte (48°)	38 mm	38 mm
Ø Zaagblad	165 mm	165 mm
Gewicht	4,4 kg	4,4 kg
Prijs in €	excl. btw	
	incl. btw	

CIRKELZAGEN



5008MGJX



Zaagblad  
gratis bij  
5008MGJX  
t.w.v.



HS7101JX



2 x zaagblad 12 tanden  
bij HS7101JX t.w.v.  
2 x zaagblad 16 tanden bij  
5903RKX1 t.w.v.



HS0600



5143R

	HS6601	HS6101J	HS7601J	HS7101JX	5008MGJX	5903RKX1	HS0600	5103R	5143R
Nominaal vermogen	1050 W	1100 W	1200 W	1400 W	1800 W	2000 W	2000 W	2100 W	2200 W
Zaagdiepte (90°)	54,5 mm	54,5 mm	66 mm	67 mm	75,5 mm	85 mm	101 mm	100 mm	130 mm
Ø Zaagblad	165 mm	165 mm	190 mm	190 mm	210 mm	235 mm	270 mm	270 mm	355 mm
Gewicht	3,7 kg	3,7 kg	4,0 kg	4,0 kg	5,1 kg	7,2 kg	6,9 kg	9,4 kg	14,0 kg
Prijs in €	excl. btw								
	incl. btw								

TAFEL-, AFKORT- EN VERSTEKZAGEN



LF1000



LH1201



LH1201FL

SNELLE OMBOUW  
VAN TAFEL- NAAR  
AFKORTZAAGFUNCTIE

Verstekhoek	LH1040	LH1201	LF1000
	90°	91 x 95 mm 69 x 130 mm	95 x 155 mm 62 x 200 mm
45°	69 x 85 mm	62 x 125 mm	50 x 150 mm

		LH1040F	LH1201FL	LF1000
Nominaal vermogen		1650 W	1650 W	1650 W
Ø Zaagblad		260 mm	305 mm	260 mm
Gewicht		14,3 kg	20,7 kg	36 kg
Prijs in €	excl. btw			
	incl. btw			

AFKORT-VERSTEKZAAG



Kantelbaar naar links tot 45°

		LS1040N
Nominaal vermogen		1650 W
Ø Zaagblad		260 mm
Max. zaagdiepte 0°		91 x 95 mm
Max. zaagdiepte 45°		91 x 67 mm
Gewicht		12,4 kg
Prijs in €	excl. btw	
	incl. btw	

TAFELZAAG MET ONDERSTEL



		2704NX1
Nominaal vermogen		1650 W
Ø Zaagblad		260 mm
Gewicht		34,9 kg
Prijs in €	excl. btw	
	incl. btw	

TAFELZAAG



		MLT100N
Nominaal vermogen		1500 W
Ø Zaagblad		260 mm
Gewicht		34,7 kg
Prijs in €	excl. btw	
	incl. btw	



BOUWCIRKELZAAG



		2712
Nominaal vermogen		2000 W
Ø Zaagblad		315 mm
Gewicht		52,9 kg
Prijs in €	excl. btw	
	incl. btw	

TELESCOPISCHE AFKORT-VERSTEKZAGEN

PROMO

Gratis onderstel DEBWST06 t.w.v. bij  
LS1019L / LS1219L

Model	DEBWST06 - Onderstel
LS1019	✓  t.w.v.
LS1219	✓

Max. lengte: 2550 mm

Nieuwe bevestigingsklemmen voor het bevestigen van verstekzagen op onderstellen DEBWST06 en DEAWST07



JM00000219

# DXT

Deep and Exact Cutting Technology

De gepatenteerde constructie met drievoudige tandwieloverbrenging en uitsparing achter de flens laat toe om een groter deel van het zaagblad te benutten. Daardoor kunnen ook hoge plinten verticaal of in verstek afgekort worden.



LS1019L

LS1018L

Verstekhoek	LS1219L - Snijhoek		
	45° links	0°	45° rechts
0°	71x363 mm	107x363 mm	54x363 mm
45° L EN R	71x255 mm	107x255 mm	54x255 mm
60° L EN R	-	107x178 mm	-
PLINTEN	-	171 mm	-

Verstekhoek	LS1019L - Snijhoek		
	45° links	0°	45° rechts
0°	61x279 mm	91x279 mm	43x279 mm
45° L EN R	61x197 mm	91x197 mm	43x197 mm
60° L EN R	-	91x139 mm	-
PLINTEN	-	133 mm	-

Verstekhoek	LS0815FL - Snijhoek		
	45° links	0°	5° rechts
0°	50x305 mm	65x305 mm	60x305 mm
45° L EN R	50x215 mm	65x215 mm	-
60° R	-	65x150 mm	-

Verstekhoek	LS1018LN - Snijhoek		
	45° links	90°	45° rechts
0°	50x310 mm	91x310 mm	31x310 mm
45° L EN R	50x220 mm	91x220 mm	31x220 mm
60° R	-	91x153 mm	-

Verstekhoek	LS0714FLB - Snijhoek		
	45° links	90°	45° rechts
0°	40x300 mm	52x300 mm	40x300 mm
45° L EN R	40x212 mm	52x212 mm	-
57° R	-	52x163 mm	-

	LS0815FLN	LS1018LN	LS0714LN	LS1019L	LS1219L
Nominaal vermogen	1400 W	1430 W	1010 W	1510 W	1800 W
Ø zaagblad	216 mm	260 mm	190 mm	260 mm	305 mm
DXT	-	-	-	✓	✓
Gewicht	14,2 kg	19,9 kg	13,4 kg	26,3 kg	29,5 kg
Prijs in €	excl. btw				
	incl. btw				

ONDERSTEL AFKORT-VERSTEKZAGEN



Verbeterde bevestigingsklemmen!

o Ideaal voor het zagen van lange materialen  
o Vernieuwde bevestigingsklemmen met een veilig en handig kliksysteem om moeiteloos verstekzagen te installeren en te demonteren.  
o Gemakkelijk te transporteren

DEAWST07	
Afmetingen	1765 (l) x 750 (b) x 850 (h) mm
Max. lengte	3830 mm
Prijs in €	excl. btw
	incl. btw

HANDPALMVLAKSCHUURMACHINES



	BO4556K	BO4555K	BO4558	BO4565K
Nominaal vermogen	200 W	200 W	200 W	200 W
Afmetingen schuurvoet	112 x 102 mm	112 x 102 mm	112 x 102 mm	112 x 190 mm
Bevestiging	Klem	Velcro & klem	Klem	Velcro Driehoekspunt
Materiaal schuurvoet	Kunststof	Kunststof	Aluminium	Kunststof
Aantal schuurbewegingen	14000/min	14000/min	14000/min	14000/min
Schuuruitslag	1,5 mm	1,5 mm	1,5 mm	1,5 mm
Gewicht	1,1 kg	1,1 kg	1,2 kg	1,2 kg
Prijs in €	excl. btw			
	incl. btw			



VLAKSCHUURMACHINES MET VARIABLE SNELHEID

BO3711

	BO3711	BO4900VJ
Nominaal vermogen	190 W	330 W
Afmetingen schuurvoet	93 x 185 mm	115 x 232 mm
Aantal schuurbewegingen	4000-11000/min	4000-10000/min
Schuuruitslag	2,0 mm	2,6 mm
Gewicht	1,6 kg	2,7 kg
Prijs in €	excl. btw	
	incl. btw	

BANDSCHUURMACHINES

9403J:  
Zeer krachtig,  
ideaal voor intensief  
schuurwerk

MAK PAC  
PART NO. 1225629

9911J

9032



	9911J	9924DB	9903J	9031	9032	9920J	9404J	9403J
Nominaal vermogen	650 W	850 W	1010 W	550 W	500 W	1010 W	1010 W	1200 W
Bandsnelheid	75-270 m/min	400 m/min	210-440 m/min	200-1000 m/min	300-1700 m/min	210-440 m/min	210-440 m/min	500 m/min
Schuurband	75 x 457 mm	75 x 610 mm	75 x 533 mm	30 x 533 mm	9 x 533 mm	75 x 610 mm	100 x 610 mm	100 x 610 mm
Gewicht	2,7 kg	4,8 kg	4,3 kg	2,1 kg	1,6 kg	4,5 kg	4,8 kg	5,7 kg
Prijs in €	excl. btw							
	incl. btw							



EXCENTRISCHE SCHUURMACHINES



BO5031K



BO5041K



BO6050J

	BO5031K	BO5041K	BO6030JX	BO6050J
Nominaal vermogen	300 W	300 W	310 W	750 W
Aantal schuurbewegingen	8000-24000/min	8000-24000/min	8000-20000/min	3200-13600/min
Schuuruitslag	2,8 mm	2,8 mm	3 mm	5,5 mm
Ø Schuurvoet	123 mm	123 mm	147 mm	147 mm
Gewicht	1,3 kg	1,4 kg	2,4 kg	2,6 kg
Prijs in €	excl. btw			
	incl. btw			

HAAKSE SCHUURMACHINE



SA7000C

SA7000C	
Nominaal vermogen	1600 W
Toerental onbelast	0-4000 t.p.m.
Ø schijf	180 mm
Gewicht	3,4 kg
Prijs in €	excl. btw
	incl. btw

EXCENTRISCHE POLIJSTMACHINE



PO6000C

PO6000C	
Nominaal vermogen	890 W
Aantal schuurbewegingen	0-13600 /min.
Ø schijf	150 mm
Schuuruitslag	5,5 mm
Gewicht	2,7 kg
Prijs in €	excl. btw
	incl. btw

SCHUUR- EN POETSMACHINE



9237CB

9237CB	
Nominaal vermogen	1200 W
Toerental	0-3200 t.p.m.
Ø schijf	180 mm
Gewicht	3,4 kg
Prijs in €	excl. btw
	incl. btw

BORSTELSCUURMACHINE



9741J

9741J	
Nominaal vermogen	860 W
Toerental	3500 t.p.m.
Gewicht	4,2 kg
Prijs in €	excl. btw
	incl. btw

GASNAGELPISTOOL VOOR AFWERKNAGELS  
16 GA



**GF600SE**

Accu	7,2 V / 1,0 Ah
Gemiddelde laadtijd	30 min
Doorsnede nagel	1,6 mm
Lengte nagel	15-64 mm
Gewicht	2,2 kg
Prijs in €	excl. btw
	incl. btw

GASNAGELPISTOOL  
VOOR BETON



**GN420CSE**

Accu	7,2 V / 1,0 Ah
Gemiddelde laadtijd	30 min
Doorsnede nagel	2,6-3,0 mm
Lengte nagel	15-40 mm
Gewicht	3,5 kg
Prijs in €	excl. btw
	incl. btw

GASNAGELPISTOOL VOOR HOUT



**GN900SE**

Accu	7,2 V / 1,0 Ah
Gemiddelde laadtijd	30 min
Doorsnede nagel	2,9-3,3 mm
Lengte nagel	50-90 mm
Gewicht	3,3 kg
Prijs in €	excl. btw
	incl. btw

PNEUMATISCH NIETPISTOOL 18 GA



**AT638A**

Werkdruk	4,2 - 8 bar
Draadkaliber	18 Ga
Doorsnede niet	1,1x1,3 mm
Rugbreedte niet	5 mm
Lengte niet	15-38 mm
Gewicht	1,5 kg
Prijs in €	excl. btw
	incl. btw

PNEUMATISCH ROLNAGELPISTOOL



**AN454**

Werkdruk	4,9-8,3 bar
Doorsnede nagel	3,05 mm
Lengte nagel	19-45 mm
Gewicht	2,4 kg
Prijs in €	excl. btw
	incl. btw

PNEUMATISCH CONSTRUCTIE-  
NAGELPISTOOL 21°



**AN924**

Werkdruk	4,9-8,3 bar
Doorsnede nagel	3,76 mm
Lengte nagel	50-90 mm
Gewicht	3,8 kg
Prijs in €	excl. btw
	incl. btw

MINIBRADPISTOOL 18 GA



**AF506**

Werkdruk	4,8-8,3 bar
Draadkaliber	18 Ga
Ø Nagelkop	2,0 mm
Doorsnede nagel	1,2 mm
Lengte nagel	15-50 mm
Gewicht	1,4 kg
Prijs in €	excl. btw
	incl. btw

BRADPISTOOL 16 GA



**AF601**

Werkdruk	0,49 - 8,3 bar
Draadkaliber	16 Ga
Doorsnede nagel	1,6 mm
Lengte nagel	25 - 64 mm
Gewicht	1,7 kg
Prijs in €	excl. btw
	incl. btw

PNEUMATISCH  
CONSTRUCTIENAGELPISTOOL 34°



**AN943K**

Werkdruk	4,5-8,5 bar
Ø Nagelkop	7,0 mm
Doorsnede nagel	2,9-3,3 mm
Lengte nagel	50-90 mm
Gewicht	3,9 kg
Prijs in €	excl. btw
	incl. btw

LASERAFSTANDSMETER



LD080PI



LD030P



	LD030P	LD050P	LD080PI
Bereik	30 m	50 m	80 m
Gewicht	0,1 kg	0,1 kg	0,1 kg
Prijs in €	excl. btw		
	incl. btw		

ROTARENDE LASER



INCLUSIEF:  
statief 2,7 m  
t.w.v.



Inclusief ontvanger, bril voor laser, afstandsbediening en wandbevestiging

		SKR200Z
Rotatiesnelheid		0-600 t.p.m.
Bereik		100 m
Gewicht		1,6 kg
Prijs in €	excl. btw	
	incl. btw	

ACCU MUURSCANNER



- De DWD181 gebruikt radartechnologie om nauwkeurig metaal, hout, elektrische bekabeling en andere objecten in wanden en vloeren te detecteren

4,1 inch kleurscherm



		DWD181ZJ
Spanning		14,4 V/18 V
Max. detectiediepte		25 - 180 mm
Tolerantie detectiediepte		± 5 mm
Minimum detecteerbare afstand tussen objecten		40 mm
Bijgeleverde lader/accu		-
Gewicht zonder accu		1,0 kg
Prijs in €	excl. btw	
	incl. btw	

KRUISLIJN- EN LIJNLASERS (CXT)

SK105DZ, SK105GDZ,  
SK106DZ & SK106GDZ  
**INCLUSIEF:**  
BL1021B + DC10SB



SK105DZ



SK106GDZ

Kruislijn + 4 punten

SK106GD



SK106D

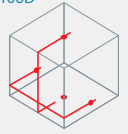

Kruislijn

SK105GD



SK105D



SK105DZ SK105GDZ SK106DZ SK106GDZ

Kleur	Rood	Groen	Rood	Groen
Projecties	1 H - 1 V	1 H - 1 V	1 H - 1 V + 4 punten	1 H - 1 V + 4 punten
Nauwkeurigheid	+3 mm / 10 m	+3 mm / 10 m	+3 mm / 10 m	+3 mm / 10 m
Bereik	25 m	25 m	25 m	25 m
Bijgeleverde accu's	1 x BL1021B + DC10SB	1 x BL1021B + DC10SB	1 x BL1021B + DC10SB	1 x BL1021B + DC10SB
Gewicht	0,67 kg	0,67 kg	0,69 kg	0,69 kg
Prijs in €	excl. btw			
	incl. btw			

**SK10GD/SK20GD/SK40GD**

- Groene laser met hoge helderheid
- Uiterst nauwkeurig
- Stevige constructie, beschermingsklasse IP54

Horizontaal /  
4-Verticale lijnen

Horizontaal /  
2-Verticale lijnen

Kruislijn + Punt

SK40GD

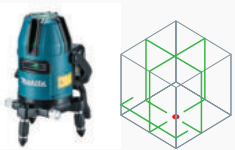

SK20GD

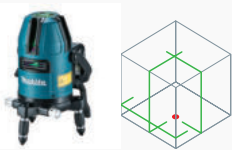

SK10GD

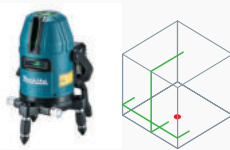

SK10GDZ, SK20GDZ, SK40GDZ  
SK209GDZ & SK312GDZ  
**INCLUSIEF:**  
Powerpack 197658-5



1 horizontale + 3 verticale lijnen  
SK312GDZ



1 horizontale + 2 verticale lijnen  
SK209GDZ



SK209GDZ



SK312GDZ

SK10GDZ SK20GDZ SK40GDZ SK209GDZ SK312GDZ

Kleur	Groen	Groen	Groen	Groen	Groen
Projecties	1 H - 1 V + loodpunt	1 H - 2 V + loodpunt	1 H - 4 V + loodpunt	1 H - 2 V + loodpunt	1 H - 3 V + loodpunt
Nauwkeurigheid	±1 mm/10 m	±1 mm/10 m	±1 mm/10 m	+1 mm / 10 m	+1 mm / 10 m
Bereik	-	-	-	-	-
Bijgeleverde accu's	2x BL1021B + DC10SB	2x BL1021B + DC10SB	2x BL1021B + DC10SB	2x BL1021B + DC10SB	2x BL1021B + DC10SB
Gewicht	1,4 - 1,6 kg	1,4 - 1,6 kg	1,4 - 1,6 kg	1,5 - 1,6 kg	1,5 - 1,6 kg
Prijs in €	excl. btw				
	incl. btw				

KRUISLIJN- EN LIJNLASERS (CXT)

**SK700DZ/SK700GDZ:**

- 3x 360° laser (3 stralen: 1 horizontaal 360° + 2 verticaal 360°).
- Zeer hoge nauwkeurigheid.
- Blokkeerstand voor projectie van schuine lijnen en voor transport.
- Zeer grote autonomie dankzij de 12Vmax CXT batterij.
- IP54 bescherming.



**Hoge intensiteit**  
De SK700GDZ met krachtige groene laser biedt een uitstekende zichtbaarheid, ook in een omgeving met invallend daglicht.

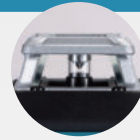

**SK700DZ: 360°**

Via een sneldraaiende conische spiegel wordt de laserstraal over 360° geprojecteerd.



**SK700DZ:**

**Fijnafstelling:** Via een knop op de basis kan de unit zeer precies over een bereik van 10° gedraaid worden. De bevestiging is excentrisch zodat de kruising van de lijnen bij het draaien op hetzelfde punt blijft.



**SK700DZ:**

**Helderheidsinstelling**  
Via de 3 helderheidsinstellingen (100% - 75% - 50%) kan de intensiteit van de laser perfect aangepast worden aan de omstandigheden.



SK700DZ



SK700GDZ



SK700DZ & SK700GDZ  
**INCLUSIEF:**  
Powerpack 197658-5



**OPTIONEEL CP00000001**  
ADP09 Batterij adapter voor SK700  
Werkt met 8 x 1,5V AA-batterijen  
excl btw:  
incl btw:



	SK700DZ	SK700GDZ
Kleur	Rood	Groen
Projecties	3 x 360° rood	3 x 360° groen
Nauwkeurigheid	±2mm/10m	±2mm/10m
Bereik	25 m	35 m
Bijgeleverde accu's	2x BL1021B + DC105B	2x BL1021B + DC105B
Gewicht	0,99 - 1,2 kg	0,99 - 1,2 kg
Prijs in €	excl. btw	
	incl. btw	

**Accessories**

**TK0LM2000F**

Statief 400 - 1140 mm  
excl btw:  
incl btw:



**TK0LM4001F**

Statief 680 - 1800 mm  
excl btw:  
incl btw:



**TK0LM5030F**

Statief 780 - 2900 mm  
excl btw:  
incl btw:



**LE00870137**

Muur- en plafondbevestiging SK105, SK106, SK700  
excl btw:  
incl btw:



**TK00ET03F1**

Muur- en plafondbevestiging SK10, SK20, SK40, SK209, SK312  
excl btw:  
incl btw:



**LE00855702**

Laserlijntonvanger (80 m) SK105, SK106, SK700  
excl btw:  
incl btw:



**TK0LDG501G**

Laserlijntonvanger SK10, SK20, SK40  
excl btw:  
incl btw:



**TK0LDG301G**

Laserlijntonvanger SK209, SK312  
excl btw:  
incl btw:



**DECADP05**

Adapter voor LXT batterijen  
excl btw:  
incl btw:



**199178-5**

USB voedingskabel voor ADP05 (SK105 / SK106)  
excl btw:  
incl btw:



**199010-3**

USB voedingskabel voor ADP05 (SK209 / SK312)  
excl btw:  
incl btw:



## DLX4160PT2

ACCU COMBOPACK TUIN

18v + 18v → 36v

18V LITHIUM-ION



### DLX4160PT2

Bijgeleverde accu's	2 x accu 5,0 Ah
Duo snellader	DC18RD
Heggenschaar	DUH602
Bladblazer	DUB184
Grastrimmer	DUR181
Grasmaaier	DLM432
Prijs in €	excl. btw
	incl. btw

## DLX5057PTJ

ACCU COMBOPACK TUIN

18v + 18v → 36v

XPT

BL MOTOR

18V LITHIUM-ION



### DLX5057PTJ

Bijgeleverde accu's	4 x accu 5,0 Ah
Duo snellader	DC18RD
Heggenschaar	DUH601
Kettingzaag	DUC353
Grastrimmer	DUR368
Grasmaaier	DLM460
Bladblazer	DUB362
Prijs in €	excl. btw
	incl. btw

**LXT** 18v + 18v → 36v



1 accu 6,0 Ah gratis

Bij aankoop van een 2 x 18V machine op deze pagina

LXT machines  
geleverd zonder  
batterijen of lader



XGT machines  
zijn geleverd met  
batterij(en) en lader

1 accu 4,0 Ah gratis

Bij aankoop van een 40Vmax machine op deze pagina

## US053DZ / DUS054Z

ACCU COMPACTE SPROEIER

UITSCHUIFBARE SPUITLANS: 0,5 – 0,7 M

**18V**  
LITHIUM-ION

**12Vmax**  
LITHIUM-ION

DUS054Z



- Schoudergedragen model met een 5 l tank
- De twee spuitmondjes zijn afzonderlijk te activeren voor smal of breed sproeien.

		US053DZ	DUS054Z
Spanning		12Vmax	18 V
Bijgeleverde accu's		0	0
Tankinhoud		5 l	5 l
Debiet		0,2 l/min	0,2 l/min
Max. druk		2,6 bar	2,6 bar
Afmetingen		340 x 183 x 360 mm	340 x 183 x 360 mm
Gewicht		2,9 - 3,0 kg	3,2 - 3,5 kg
Prijs in €	excl. btw		
	incl. btw		

## DUS108Z / DUS158Z

ACCU RUGSPROEIERS

DUS108Z: Leverbaar vanaf november

**18V**  
LITHIUM-ION

DUS108Z



DUS158Z



		DUS108Z	DUS158Z
Spanning		18 V	18 V
Bijgeleverde accu's		0	0
Tankinhoud		10 l	15 l
Debiet		0,8 - 1,3 l/min	0,8 - 1,3 l/min
Max. druk		3,0 bar	3,0 bar
Afmetingen		325 x 237 x 439 mm	325 x 237 x 517 mm
Gewicht		4,6 kg	4,6 kg
Prijs in €	excl. btw		
	incl. btw		

## HW1200 / HW1300 / HW131 / HW151

ELEKTRISCHE HOGEDRUKREINIGERS

HW1300



HW151



HW131



		HW1200	HW1300	HW131	HW151
Vermogen		1800 W	1800 W	2200 W	2500 W
Max. druk		120 bar	130 bar	130 bar	150 bar
Max. debiet		420 l/h	420 l/h	500 l/h	500 l/h
Haspel		10 m	10 m	15 m	10 m
Gewicht		11,0 kg	12,7 kg	33 kg	26,9 kg
Prijs in €	excl. btw				
	incl. btw				



## DHW080ZK

ACCU HOGEDRUKREINIGERS

Capaciteit  
watertank

**50 l**

Werkdruk

**30/55 bar**

Debiet

**4,0/5,5 l/min**

18V + 18V → 36V

**PROMO**

GRATIS ACCU 6,0 Ah  
na online registratie











### Compatibel



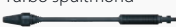





Er is een breed assortiment aan hulpstukken beschikbaar, ze zijn ook compatibel met de HW1200 / HW1300.

### DHW080ZK

Spanning	2 x 18 V
Bijgeleverde accu's	-
Lader	-
Werkdruk (laag/hoog)	30/55 bar
Debiet (laag/hoog)	4,0/5,5 l/min
Inhoud watertank	50 l
Gewicht	7,1-7,7 kg
Prijs in €	excl. btw
	incl. btw

## Sproeikoppen

Vorm	Geschikt voor model	Ref.	Prijs (excl. BTW)	Prijs (incl. BTW)
 Spuithandgreep	DHW080 HW1200 HW1300	197842-2		
 Regelbare spuitmond	DHW080 HW1200 HW1300	197822-8		
 Vario-spray lans	DHW080 HW1200 HW1300	197876-5		
 Turbo spuitmond	DHW080 HW1200 HW1300	197824-4		
 Terrasreiniger	DHW080 HW1200 HW1300	197864-2		
 Haakse spuitlans	HW1200 HW1300	198909-9		
 Verlengset voor spuithandgreep	DHW080 HW1200 HW1300	197870-7		
 Reinigingsnaald	DHW080 HW1200 HW1300	197879-9		
 Ronde borstel	DHW080 HW1200 HW1300	197831-7		
 Rechte borstel	DHW080 HW1200 HW1300	197828-6		

Vorm	Geschikt voor model	Ref.	Prijs (excl. BTW)	Prijs (incl. BTW)
 Schuimgenerator	DHW080 HW1200 HW1300	197886-2		
 Afvoerbuisreiniger	DHW080 HW1200 HW1300	10 m 197837-5 15 m 197840-6		
 Hogedrukslang	DHW080 HW1200 HW1300	5 m 197845-6 8 m 197847-2 10 m 197850-3		
 Draaikoppelstuk	DHW080 HW1200 HW1300	197867-6		
 Waterzuigset	DHW080 HW1200 HW1300	197873-1		
 Koppelstuk	DHW080 HW1200 HW1300	197853-7		
 Waterkoppeling	DHW080 HW1200 HW1300	197881-2		
 Snelkoppelstuk	DHW080 HW1200 HW1300	197883-8		

## DCU180Z

ACCU KRUIWAGEN 18 V



Elektronische snelheidsregeling



Demonteerbare achterwielen



Geïntegreerde ledverlichting



### PROMO

BUIZENFRAME  
(199009-8) +  
2 x ACCU 5 Ah +  
lader DC18RC



### DCU180Z

Rijsnelheid	0 - 3,5 km/u
Draagvermogen	130 kg
Max. helling	12°
Prijs in €	excl. btw
	incl. btw

## DUP362Z / DUP362PT2

ACCU SNOEISCHAAR 2 x 18 V



Inclusief  
harnas & holster



	DUP362Z	DUP362PT2
Bijgeleverde accu's	-	2 x accu 5,0 Ah
Lader	-	DC18RD
Max. takdikte	33 mm	33 mm
Rugzak harnas	✓	✓
Gewicht	3,3 kg	3,3 kg
Prijs in €	excl. btw	
	incl. btw	

## UD2500

ELEKTRISCHE HAKSELAAR



### UD2500

Vermogen	2500 W
Max. toerental onbelast	40 t.p.m
Max. takdikte	45 mm
Geluidsdruk	84 dB(A)
Gewicht	29,7 kg
Prijs in €	excl. btw
	incl. btw

## DDG460ZX7 / DDG460T2X7

ACCU GRONDBOOR 2 x 18 V



DDG460ZX7

18v + 18v → 36v

**LXT**  
**ADT**  
**BL**  
MOTOR  
**XPT**

	DDG460ZX7	DDG460T2X7
Platform	LXT 2 x 18 V	
Max. boorcapaciteit	200 mm	
Max. koppel	136 Nm	
Gewicht	7,3 - 8,2 kg	
Bijgeleverde accu's	-	2x BL1850B
Bijgeleverde lader	-	DC18RD
Prijs in €	excl. btw	
	incl. btw	

## DG001GZ05 / DG001GM105

ACCU GRONDBOOR 40VMAX



DG001GM105

**XGT**  
**40V**  
LITHIUM  
max  
**WG**  
WET GUARD  
**ADT**  
**BL**  
MOTOR  
**XPT**

	DG001GZ05	DG001GM105
Platform	40Vmax	
Max. boorcapaciteit	200 mm	
Max. koppel	136 Nm	
Gewicht	7,2 - 8,1 kg	
Bijgeleverde accu's	-	1x BL4040
Bijgeleverde lader	-	DC40RA
Prijs in €	excl. btw	
	incl. btw	

### Adapters voor grondboren



**327687-6**  
Adapter Type D  
voor Makita grondboren



**327684-2**  
Adapter Type A  
voor Stihl grondboren

### Grondboren met hexagonale schacht

Artikel nr.	Diameter	Totale lengte	Nuttige lengte	Prijs (Excl. BTW)	Prijs (Incl. BTW)
D-75437	Ø 70 mm	600 mm	200 mm		
D-75443	Ø 100 mm	600 mm	200 mm		
D-75459	Ø 130 mm	600 mm	200 mm		

### Grondboren te gebruiken met adapter (type D) incl. borgpen

Artikel nr.	Diameter	Totale lengte	Nuttige lengte	Prijs (Excl. BTW)	Prijs (Incl. BTW)
E-13611	Ø 50 mm	800 mm	550 mm		
E-13627	Ø 60 mm	800 mm	550 mm		
E-13633	Ø 80 mm	800 mm	550 mm		
E-07294	Ø 100 mm	800 mm	550 mm		
E-07303	Ø 150 mm	800 mm	550 mm		
E-07319	Ø 200 mm	800 mm	550 mm		

Vervangmesjes	Voor grondboor diameter	Prijs (Excl. BTW)	Prijs (Incl. BTW)
E-13649	50 mm		
E-13655	60 mm		
E-13661	80 mm		
E-07630	100 mm		
E-07646	150 mm		
E-07652	200 mm		



**E-07325**  
Verlengstuk  
540 mm



**E-07331**  
Borgpen



### Slipkoppeling

De slipkoppeling verbreekt de verbinding tussen de motor en de boor wanneer het koppel een extreme waarde overschrijdt. Dat voorkomt schade aan de machine en verhoogt de veiligheid voor de gebruiker.



### Omkeerschakelaar

De draairichting kan omgekeerd worden om de boor los te maken wanneer ze geblokkeerd geraakt is of te diep vastzit in zware kleigrond.



## DUC122RTE / DUC122ZK / DUC254Z

ACCU SNOEIKETTINGZAGEN 18 V

OPGELET: voor het gebruik van een tophandle kettingzaag is een opleiding vereist. Raadpleeg steeds de veiligheidsvoorschriften.



18V LITHIUM-ION

XPT  
EXTRA PROTECTION TECHNOLOGY  
DUC254

BL  
MOTOR  
DUC254



	DUC254Z	DUC122ZK	DUC122RTE
Bijgeleverde accu's	-	-	2 x accu 5,0 Ah + DC18RC
Zwaardlengte	25 cm	11,5 cm	11,5 cm
Kettingsnelheid	24 m/s	5 m/s	5 m/s
Gewicht	2,9 kg	2,6 kg	2,6 kg
Prijs in €	excl. btw		
	incl. btw		

## DUC252Z / -302Z / -256Z / -306Z / -356Z / -406Z

ACCU SNOEIKETTINGZAGEN 2 x 18 V



Met snelspansysteem

Met geïntegreerde moer

### PROMO

GRATIS ACCU 6,0 Ah na online registratie DUC256Z, DUC306Z, DUC356Z, DUC406Z

XPT  
EXTRA PROTECTION TECHNOLOGY

BL  
MOTOR

DUC256  
DUC306  
DUC356  
DUC406

### Accessoires

18V + 18V → 36V

#### 346809-9

Boomaanslag geschikt voor: DUC256, DUC306, DUC356, DUC406, UC002G, UC003G, UC004G, UC006G (excl. btw) / (incl. btw)



	DUC252Z	DUC302Z	DUC256Z	DUC306Z	DUC356Z	DUC406Z
Bijgeleverde accu's	-	-	-	-	-	-
BL motor	-	-	✓	✓	✓	✓
Zwaardlengte	25 cm	30 cm	25 cm	30 cm	35 cm	40 cm
Snelspansysteem	✓	✓	-	-	-	-
Geïntegreerde moeren	-	-	✓	✓	✓	✓
Kettingsnelheid	8,3 m/s	8,3 m/s	20 m/s	20 m/s	20 m/s	20 m/s
Gewicht	4,6 kg	4,7 kg	4,6 kg	4,6 kg	4,6 kg	4,6 kg
Prijs in €	excl. btw					
	incl. btw					

## UC002GZ / UC002GM101 / UC003GZ / UC003GM101 / UC004GZ / UC004GM101 / UC006GZ

ACCU SNOEIKETTINGZAGEN 40VMAX

### PROMO

GRATIS ACCU 4,0 Ah na online registratie UC002GM101, UC003GM101, UC004GM101

XPT  
EXTRA PROTECTION TECHNOLOGY

BL  
MOTOR

WG  
WET GUARD

XPT  
40Vmax



Met carvingblad

HOOG UITGANGSVERMOGEN  
COMPACT  
HOGE KETTINGSNELHEID

	UC002GZ	UC002GM101	UC003GZ	UC003GM101	UC004GZ	UC004GM101	UC006GZ
Bijgeleverde accu's	-	1x 4,0 Ah	-	1x 4,0 Ah	-	1x 4,0 Ah	-
Bijgeleverde lader	-	DC40RA	-	DC40RA	-	DC40RA	-
Zwaardlengte	25 cm	25 cm	30 cm	30 cm	35 cm	35 cm	25 cm
Ketting	3/8" 1,1 mm	3/8" 1,1 mm	3/8" 1,1 mm	3/8" 1,1 mm	3/8" 1,1 mm	3/8" 1,1 mm	1/4" 1,3 mm
Kettingsnelheid	0 - 24,8 m/s	0 - 24,8 m/s	0 - 24,8 m/s	0 - 24,8 m/s	0 - 24,8 m/s	0 - 24,8 m/s	0 - 24,8 m/s
Gewicht	3,8 - 4,7 kg	3,8 - 4,7 kg	3,8 - 4,7 kg	3,8 - 4,7 kg	3,8 - 4,7 kg	3,8 - 4,7 kg	3,8 - 4,7 kg
Prijs in €	excl. btw						
	incl. btw						

Beschikbaar vanaf november

## DUC353Z / DUC405Z

ACCU KETTINGZAGEN 2 x 18V

18V + 18V → 36V

DUC405Z



**PROMO**

GRATIS ACCU 6,0 Ah  
na online registratie

		DUC353Z	DUC405Z
Bijgeleverde accu's		-	-
Zwaardlengte		35 cm	40 cm
Bevestiging zwaard		Snelspansysteem	Geïntegreerde moeren
Kettingsnelheid		20 m/s	20 m/s
Gewicht		4,7 kg	4,8 kg
Prijs in €	excl. btw		
	incl. btw		

## DUC307ZX2 / DUC307RTX2 / DUC357ZX2 / DUC357RTX2

ACCU KETTINGZAGEN 18 V

- Robuuste kettingzaag met lage kettingsnelheid en hoog koppel
- Gereedschapsloze kettingspanner
- Laag geluidsniveau



DUC357RTX2

18V  
LITHIUM-ION

		NIEUW DUC307ZX2	NIEUW DUC307RTX2	NIEUW DUC357ZX2	NIEUW DUC357RTX2
Bijgeleverde accu's		-	1x BL1850B	-	1x BL1850B
Bijgeleverde lader		-	DC18RC	-	DC18RC
Zwaardlengte		30 cm	30 cm	35 cm	35 cm
Ketting		3/8" 1,1 mm	3/8" 1,1 mm	3/8" 1,1 mm	3/8" 1,1 mm
Kettingsnelheid		7,7 m/s	7,7 m/s	7,7 m/s	7,7 m/s
Gewicht		4,2-4,4 kg	4,2-4,4 kg	4,2-4,4 kg	4,2-4,4 kg
Prijs in €	excl. btw				
	incl. btw				

## UC010GZ / UC010GT101 / UC011GZ / UC011GT101 / UC012GZ / UC012GT102 / UC013GZ01 / UC013GT102

ACCU KETTINGZAAG 40Vmax



UC012GT102



UC013GT102

WG  
WET GUARD

XGT  
40Vmax

HOOG VERMOGEN  
HOGE KETTINGSNELHEID  
REGLBAAR OLIEDEBIET  
LAAG TRILLINGSNIVEAU

		UC010GZ	UC010GT101	UC011GZ	UC011GT101	UC012GZ01	UC012GT102	UC013GZ01	UC013GT102
Bijgeleverde accu's		-	1 x 5,0 Ah	-	1 x 5,0 Ah	-	1 x 5,0 Ah	-	1 x 5,0 Ah
Bijgeleverde lader		-	DC40RA	-	DC40RA	-	DC40RA	-	DC40RA
Zwaardlengte		30 cm	30 cm	35 cm	35 cm	40 cm	40 cm	45 cm	45 cm
Ketting		0,325" 1,1 mm	0,325" 1,1 mm	0,325" 1,1 mm	0,325" 1,1 mm	3/8" 1,3 mm	3/8" 1,3 mm	3/8" 1,3 mm	3/8" 1,3 mm
Kettingsnelheid		0 - 25,5 m/s	0 - 25,5 m/s	0 - 25,5 m/s	0 - 25,5 m/s	0 - 25,5 m/s	0 - 25,5 m/s	0 - 25,5 m/s	0 - 25,5 m/s
Gewicht		6,1 - 7,4 kg	6,1 - 7,4 kg	6,1 - 7,4 kg	6,1 - 7,4 kg	6,1 - 7,4 kg	6,1 - 7,4 kg	6,1 - 7,4 kg	6,1 - 7,4 kg
Prijs in €	excl. btw	,00	,00	,00	,00	,00	,00	,00	,00
	incl. btw	,99	,89	,25	,15	,09	,99	,35	,25

## DUA301Z / DUA301PT2

ACCU HOOGSNOEIER 2 x 18V

18V + 18V → 36V

TELESCOPISCHE STEEL  
COMPACTE EN LICHTE  
ZAAGKOP  
UITSTEKENDE BALANS

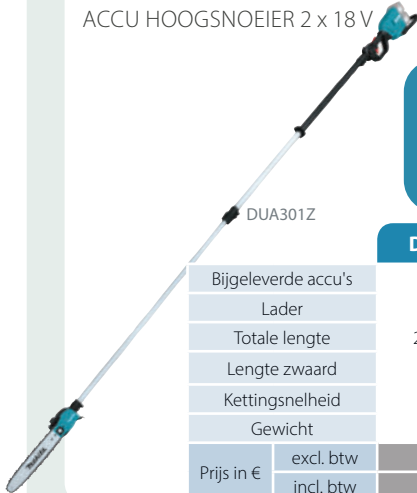

DUA301Z

		DUA301Z	DUA301PT2
Bijgeleverde accu's		0	2x 5,0 Ah
Lader		-	DC18RD
Totale lengte		2,53 - 3,76 m	2,53 - 3,76 m
Lengte zwaard		30 cm	30 cm
Kettingsnelheid		0 - 20 m/s	0 - 20 m/s
Gewicht		7,8 - 8,5 kg	7,8 - 8,5 kg
Prijs in €	excl. btw		
	incl. btw		

## UA004GZ / UA004GM101

ACCU HOOGSNOEIER 40VMAX

WG  
WET GUARD

XGT  
40Vmax



UA004GZ

		UA004GZ	UA004GM101
Bijgeleverde accu's		-	1x 4,0 Ah
Lader		-	DC40RA
Totale lengte		2,53 - 3,76 m	2,53 - 3,76 m
Lengte zwaard		30 cm	30 cm
Kettingsnelheid		0 - 20 m/s	0 - 20 m/s
Gewicht		7,8 - 9,1 kg	7,8 - 9,1 kg
Prijs in €	excl. btw		
	incl. btw		

## UR002GZ01 / UR006GZ02 / UR006GM101 / UR007GZ01 / UR007GM101

ACCU BOSMAAIERS 40VMAX



**XGT** **40Vmax**

**ADT**  
**AFT**

**WG** **XPT**  
WET GUARD EXTREME PROTECTION TECHNOLOGY

**PROMO**

Gratis accu 4,0Ah na online registratie UR006GM101 en UR007GM101

### UR006G/UR007G:

Uitstekende balans dankzij de achteraan geplaatste motor. De BL motor met geforceerde koeling levert een maximaal vermogen van 1,0 kW. Zeer hoge rotatiesnelheid.

UR006G: met beugelhandgreep ("U")  
UR007G: met ronde handgreep ("D")  
Geschikt voor zware toepassingen.

### UR002G

De boven de maaikop geplaatste BL motor met externe rotor werkt efficiënt en heeft een hoog koppel.

	UR002GZ01	UR006GZ02	UR006GM101	UR007GZ01	UR007GM101
Spanning	40Vmax	40Vmax	40Vmax	40Vmax	40Vmax
Max. toerental onbelast	3500 - 5300 - 6500 min <sup>-1</sup>	4600 - 5500 - 7000 min <sup>-1</sup>	4600 - 5500 - 7000 min <sup>-1</sup>	4600 - 5500 - 7000 min <sup>-1</sup>	4600 - 5500 - 7000 min <sup>-1</sup>
Snelheden	3 + auto	3 + auto	3 + auto	3 + auto	3 + auto
Handgreepvorm	Beugel ("U")	Beugel ("U")	Beugel ("U")	Rond ("D")	Rond ("D")
Bijgeleverde accu's	0	0	1 x BL4040	0	1 x BL4040
Bijgeleverde lader	0	0	DC40RA	0	DC40RA
Gewicht	4,6 - 5,3 kg	5,7 - 6,3 kg	5,7 - 6,3 kg	5,7 - 6,3 kg	5,7 - 6,3 kg
Prijs in €	excl. btw				
	incl. btw				

## UR012GZ02

ACCU BOSMAAIER 2 x 40VMAX

**BL** **MOTOR**

**XPT** EXTREME PROTECTION TECHNOLOGY

**ADT**

**AFT**

**WG** **WET GUARD**

**XGT X2** **80Vmax**

Extreem hoog vermogen dankzij de 2 x 40Vmax technologie.

De BL motor met geforceerde koeling levert een vermogen van maximaal 2,0 kW.

Geschikt voor de zwaarste toepassingen zoals het maaien/verhakselen van taai gras of riet en het zagen van dunne stammen.

Max. geleverd vermogen  
**2,0** kW



UR012GZ02

### UR012GZ02

Spanning	2 x 40Vmax
Toerental	3500 - 5000 - 6800 min <sup>-1</sup>
Snelheden	3 + auto
ADT	✓
AFT	✓
Bijgeleverde accu's	0
Bijgeleverde lader	-
Gewicht	8,0 - 9,8 kg
Prijs in €	excl. btw
	incl. btw

### UR100DSAEX / UR100DSMEX

ACCU GRASTRIMMER 12VMAX



**OPTIONEEL DRAADKOP 198854-8**  
Excl. btw

		UR100DSAEX	UR100DSMEX
Bijgeleverde accu's		2 x accu 2,0 Ah	2 x accu 4,0 Ah
Oplader		DC10SB	DC10SB
Handgreepvorm		D	D
Gewicht		2,34 kg	2,34 kg
Prijs in €	excl. btw		
	incl. btw		

### DUR181Z / DUR181RF

ACCU GRASTRIMMER 18V

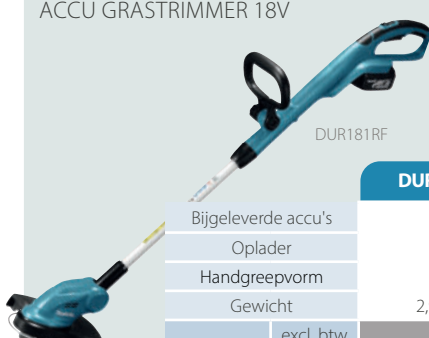

		DUR181Z	DUR181RF
Bijgeleverde accu's		-	1 x accu 3,0 Ah
Oplader		-	DC18RC
Handgreepvorm		D	D
Gewicht		2,9 kg	2,9 kg
Prijs in €	excl. btw		
	incl. btw		

### DUR194ZX3 / DUR194SFX2 / DUR192LZ / DUR192LST / DUR190LZX3 / DUR190LRT3 / DUR191LZX3 / DUR189Z / DUR189RFE

ACCU GRASTRIMMERS 18V



**PROMO**  
Gratis accu 6,0Ah na online registratie DUR189RFE

**NIEUW** **NIEUW**

		DUR194ZX3	DUR194SFX2	DUR192LZ	DUR192LST	DUR190LZX3	DUR190LRT3	DUR191LZX3	DUR189Z	DUR189RFE
Bijgeleverde accu's		-	1 x BL1830B	-	1 x accu 5,0 Ah	-	2 x accu 5,0 Ah	-	-	2 x accu 3,0 Ah
Lader		-	DC18SD	-	DC18SD	-	DC18RC	-	-	DC18RC
Snelheden		2	2	2	2	3	3	3	3	3
ADT		-	-	-	-	✓	✓	✓	✓	✓
AFT		-	-	-	-	✓	✓	✓	-	-
Handgreepvorm		D	D	D	D	D	D	D	D	D
Schacht		Standaard	Standaard	Standaard	Standaard	Standaard	Standaard	Demonteerbaar	Ergonomisch	Ergonomisch
Gewicht		2,6 kg	2,6 kg	2,7 kg	3,4 kg	3,1 kg	3,1 kg	3,1 kg	3,4 kg	3,4 kg
Prijs in €	excl. btw									
	incl. btw									

### DUR368LZ / DUR368AZ / DUR369AZ

ACCU BOSMAAIERS 2 x 18V



**PROMO**  
Gratis accu 6,0Ah na online registratie

Geleverd zonder batterijen of lader

**18V + 18V → 36V**

		DUR368LZ	DUR368AZ	DUR369AZ
Max. toerental onbelast		6500 t.p.m.	6500 t.p.m.	7000 t.p.m.
Snelheden		3	3	3
Handgreepvorm		D	Beugel	Beugel
ADT		✓	✓	✓
AFT		✓	✓	✓
Gewicht		4,2 kg	4,2 kg	6,0 kg
Prijs in €	excl. btw			
	incl. btw			

### UR101CZ / UR101CPT4J

BOSMAAIER MET DIRECTE AANSLUITING OP ACCUPAK

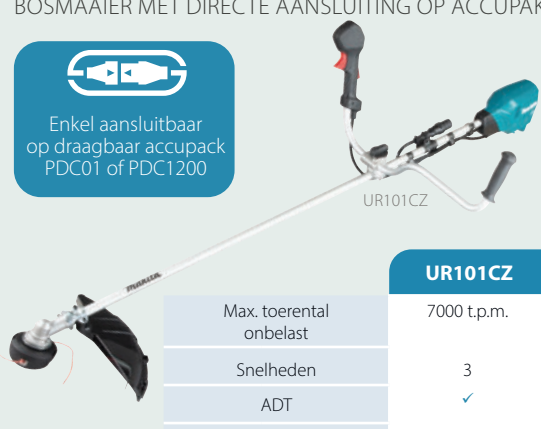

Enkel aansluitbaar op draagbaar accupack PDC01 of PDC1200

		UR101CZ	UR101CPT4J
Max. toerental onbelast		7000 t.p.m.	7000 t.p.m.
Snelheden		3	3
ADT		✓	✓
AFT		✓	✓
Handgreepvorm		Beugel	Beugel
Bijgeleverde accu's		-	4 x accu 5,0 Ah
Lader		-	DC18RD
Inclusief PDC01		-	✓
Prijs in €	excl. btw		
	incl. btw		

## UB001CZ / UB002CZ

BLADBLAZER MET DIRECTE AANSLUITING OP ACCUPACK

### UB001CZ

Voor gebruik met PDC01/PDC1200

AANGEPASTE LUCHTSTROOM VOOR BETERE PRESTATIES EN MEER GEBRUIKSGEMAK

LAAG GELUIDSNIVEAU

LICHTGEWICHT



UB001CZ



UB002CZ

**NIEUW**

### UB002CZ

- Ruggedragen bladblazer unit voor gebruik in combinatie met accupack PDC1200
- Hoge blaaskracht (tot 22 N)
- Grote autonomie
- Variabele snelheid en cruise control (aanhouden gekozen snelheid)
- Laag geluidsniveau
- Verstelbare handgreep

	UB001CZ	UB002CZ
Platform	Draagbaar accupack	Draagbaar accupack (enkel PDC1200)
Max. lichtsnelheid	70 m/s	71,7 m/s
Max. debiet	17,6 m <sup>3</sup> /min	0 - 19 m <sup>3</sup> /min
Gewicht	2,6 kg	15,9-16,1 kg
Max. blaaskracht	15 N (20 N Boost)	22 N
Prijs in €	excl. btw	
	incl. btw	

## Draagbaar accupack

### PDC1200

Met geïntegreerde accu's. Compatibel met machines met directe aansluiting en mits adapter met 2x18V en 40Vmax machines.



### BEAPDC1200A01



### PDC01

Kan tot 4 LXT batterijen bevatten. Compatibel met machines met directe aansluiting en mits adapter met 18V, 2x18V en 40Vmax machines.



### 191A59-5 (zonder batterijen)

### 191C50-5 (incl. 4 x BL1850B + DC18RD)

## Adapters



\* Compatibel met 18V LXT-producten (enkel PDC01)



Compatibel met 18V x 2 LXT-producten



Compatibel met 40V XGT-producten

Adapter: ref. 191N62-4



**Niet alleen voor gebruik met machines met directe aansluiting**

Ook standaard machines die werken met 40Vmax, 2 x 18V of 18V accu's kunnen op het accupack aangesloten worden middels de juiste adapter.

Adapter: ref. 191J51-5



Adapter: ref. 191J50-7



Prijzen en promoties geldig t.e.m. 31/12/2022



## UB101DZ

ACCU BLAZER 12VMAX



### UB101DZ

Spanning	10,8 V
Luchtsnelheid	65 m/s
Max. debiet	2,6 m³/min
Gewicht	1,4 - 1,9 kg
Max. blaaskracht	1,8 N
Prijs in €	excl. btw
	incl. btw

Geleverd zonder accu / lader

## DUB186Z

ACCU BLAZER 18V



### DUB186Z

Spanning	18 V
Luchtsnelheid	56 m/s
Max. debiet	3,2 m³/min
Gewicht	1,6 - 2,1 kg
Max. blaaskracht	2,5 N
Prijs in €	excl. btw
	incl. btw

Geleverd zonder accu / lader

## DUB184Z / DUB184RT

ACCU BLADBLAZER 18V



+ Vlakke blaasmond met adapter

DUB184Z



BLOKKEERBARE VARIOSCHAKELAAR VOOR AANHOUDEN SNELHEID

### DUB184Z DUB184RT

Bijgeleverde accu's	0	1 x BL1850B + DC18RC
Luchtsnelheid	49 m/s	49 m/s
Max. debiet	12,7 m³/min	12,7 m³/min
Gewicht	3,1 kg	3,1 kg
Max. blaaskracht	10,9 N	10,9 N
Prijs in €	excl. btw	
	incl. btw	

## DUB362Z

ACCU BLADBLAZER 2 x 18V



+ Vlakke blaasmond



### DUB362Z

Bijgeleverde accu's	0
Luchtsnelheid	54 m/s
Max. debiet	13,4 m³/min
Gewicht	3,5 kg
Max. blaaskracht	14,4 N
Prijs in €	excl. btw
	incl. btw

## DUB363ZV

ACCU BLADBLAZER / -ZUIGER 2 x 18V



**PROMO**

GRATIS ACCU 6,0 Ah na online registratie

Geleverd met bladzuigset



### DUB363ZV

Bijgeleverde accu's	0
Luchtsnelheid	54 m/s
Max. debiet	13,4 m³/min
Gewicht	4,8 kg
Max. blaaskracht	14,4 N
Prijs in €	excl. btw
	incl. btw

## UB001GZ / UB001GM101

ACCU BLADBLAZER 40VMAX



Zeer hoog blaasvermogen (tot 17 N in Boost mode).  
Variabele snelheid en cruise control.  
Hertekend ontwerp voor nog hoger gebruikskomfort.  
WetGuard/IPX4 bescherming



UB001GZ

### UB001GZ UB001GM101

Spanning	36V (40Vmax)	36V (40Vmax)
Bijgeleverde accu's	0	1x BL4040
Bijgeleverde lader	-	DC40RA
Max. luchtsnelheid	64 m/s	64 m/s
Max. debiet	16,0 m³/min	16,0 m³/min
Gewicht	3,1 - 3,9 kg	3,1 - 3,9 kg
Max. blaaskracht	12 N (17 N Boost)	12 N (17 N Boost)
Prijs in €	excl. btw	
	incl. btw	

## DUX18Z / DUX18ZX1 / DUX60Z / DUX60ZN1 / DUX60ZM4 / DUX60ZX8

Max. geleverd vermogen

**0,47** kW

**PROMO**

GRATIS ACCU 6,0 Ah na online registratie DUX60Z, DUX60ZN1, DUX60ZM4, DUX60ZX8



DUX18Z



DUX60Z

Max. geleverd vermogen

**0,6** kW

		DUX18Z	DUX18ZX1	DUX60Z	DUX60ZN1	DUX60ZM4	DUX60ZX8
Platform		LXT 18 V			LXT 2 x 18 V		
Max. afgegeven vermogen		470 W			600 W		
Toerental onbelast		0 - 6800 / 0 - 9700 min <sup>-1</sup>			0 - 5700 / 0 - 8200 / 0 - 9700 min <sup>-1</sup>		
Bijgeleverde accessoires		-	EM408MP	-	EN401MP	EM404MP	EM404MP + EN401MP
Bijgeleverde accu's / laders		-	-	-	-	-	-
Prijs in €	excl. btw						
	incl. btw						

## UX01GZ / UX01GZ01

Max. geleverd vermogen

**1,0** kW

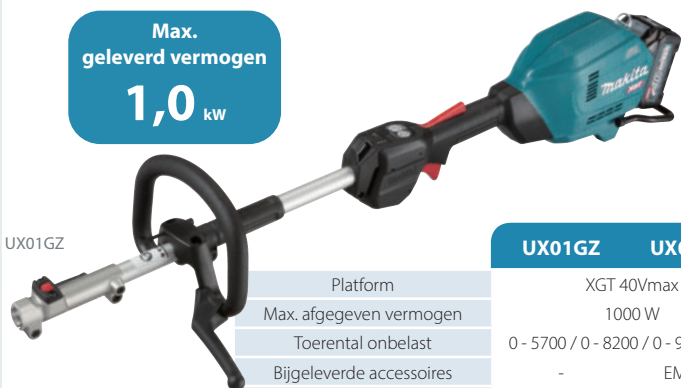

UX01GZ

UX01GZ UX01GZ01

		UX01GZ	UX01GZ01
Platform		XGT 40Vmax	
Max. afgegeven vermogen		1000 W	
Toerental onbelast		0 - 5700 / 0 - 8200 / 0 - 9700 min <sup>-1</sup>	
Bijgeleverde accessoires		-	EM404MP
Bijgeleverde accu's / laders		-	-
Prijs in €	excl. btw		
	incl. btw		

### Accessoires



**195638-5**  
Draagtas voor het combisysteem

## COMBISYSTEEM OPZETSTUKKEN

Artikel	Referentie	Ø (mm)	
BOSMAAIER (Voor DUX18 enkel EM408MP geschikt)			
EM404MP	198768-1	450 mm	
EM401MP	195888-2	300 mm	
EM400MP	195648-2	420 mm	
EM406MP	198779-6	420 mm	
EM408MP	191N31-5	300 mm	
ROTORSCHAAR			
EM407MP	191M56-3		
GRASTRIMMER			
ER400MP	195522-4	410 mm	
SNOEIKETTINGZAAG			
<b>NIEUW</b> EY403MP	191T38-7		
STOKHEGGENSCHAAR			
EN401MP	196256-2		
EN410MP	197726-4		
GRONDFREES			
KR400MP	199181-6		
BOORDENSNIJDER			
EE400MP	196752-0		
VERLENGSTUK			
LE400MP	191E24-8		
ROLVEGER			
SW400MP	199339-7		
ROLBORSTEL			
BR400MP	199318-5		
BLAZER (UB400MP ENKEL VOOR EX2650)			
UB400MP	191F65-0		
<b>NIEUW</b> UB401MP	191P72-3		

## UN460WDZ / UN460WDWA / DUN461WZ / DUN461WST / DUN500WZ

ACCU STOKHEGGENSCHAREN (CXT/LXT)

**BL**  
MOTOR

**XPT**  
EXTREME PROTECTION TECHNOLOGY

**CXT**



### DUN500WZ

- Instelbaar in 6 hoeken
- Dubbele greep voor extra comfort
- Innovatieve tandengeometrie

### DUN461

- Klassieke tandengeometrie
- Telescopische steel



DUN500WZ

DUN461WST

**18V**  
LITHIUM-ION

	UN460WDZ	UN460WDWA	DUN461WZ	DUN461WST	DUN500WZ
Accuplatform	12Vmax (CXT)	12Vmax (CXT)	18 V (LXT)	18 V (LXT)	18 V (LXT)
Bijgeleverde accu's	-	1 x accu 2,0 Ah	-	1 x accu 5,0 Ah	-
Lader	-	DC10WD	-	DC18SD	-
Snijlengte	46 cm	46 cm	46 cm	46 cm	50 cm
Maximale takdikte	18 mm	18 mm	18 mm	18 mm	23,5 mm
Gewicht	2,8 kg	2,8 kg	3,4 kg	3,4 kg	4,5 kg
Prijs in €	excl. btw				
	incl. btw				

### Accessoires



**197439-7**  
Vet tube 80ml  
Voor alle stokheggenscharen  
(excl. btw)  
(incl. btw)



**345205-8**  
Stootneus  
(excl. btw)  
(incl. btw)



**191T43-4 (DUN461)**  
Opvangkap voor snijafval  
(excl. btw)  
(incl. btw)

## DUM604ZX / DUM604RFEX / DUM111SYX / UM600DSAEX

ACCU GRAS- EN HEGGENSCHAREN 12Vmax / 18V

DUM604RFEX



**12Vmax**  
LITHIUM-ION

**18V**  
LITHIUM-ION



DUM111SYX

	UM600DSAEX	DUM111SYX	DUM604ZX	DUM604RFEX
Spanning	10,8V	18V	18V	18V
Bijgeleverde accu's	2 x accu 2,0 Ah	1 x accu 1,5 Ah	-	2 x accu 3,0 Ah
Lader	DC10SB	DC18SD	-	DC18RC
Snijlengte heggenschaar	20 cm	20 cm	20 cm	20 cm
Snijbreedte grasschaar	16 cm	11 cm	16 cm	16 cm
Gewicht	1,2 kg	1,8 kg	1,8 kg	1,8 kg
Prijs in €	excl. btw			
	incl. btw			

## UH004GZ / UH004GM201 / UH005GZ / UH005GM201

ACCU HEGGENSCHAREN 40VMAX 'TRIMVERSIE'



**PROMO**

Gratis accu 4,0Ah na online registratie UH004GM201 of UH005GM201



UH004GM201

TANDEN MET 3 GESLEPEN KANTEN EN GEBOGEN VOOR MINDER WRIJVING  
INNOVATIEVE (ASYMMETRISCHE) TANDGEOMETRIE  
IDEAAL VOOR DUNNE TAKKEN EN DICHTHE HEGGEN

	UH004GZ	UH004GM201	UH005GZ	UH005GM201
Uitvoering	Trim	Trim	Trim	Trim
Snijlengte	60 cm	60 cm	75 cm	75 cm
Max. takdikte	23,5 mm	23,5 mm	23,5 mm	23,5 mm
Aantal snijbewegingen	2000/3600/5000 min <sup>-1</sup>	2000/3600/5000 min <sup>-1</sup>	2000/3600/5000 min <sup>-1</sup>	2000/3600/5000 min <sup>-1</sup>
Bijgeleverde accu's	0	2x BL4040	0	2x BL4040
Bijgeleverde lader	0	DC40RA	0	DC40RA
Gewicht	4,3 - 4,9 kg	4,3 - 4,9 kg	4,5 - 5,1 kg	4,5 - 5,1 kg
Prijs in €	excl. btw			
	incl. btw			

## UH006GZ / UH006GM201 / UH007GZ / UH007GM201

ACCU HEGGENSCHAREN 40VMAX 'TERUGSNOEIVERSIE'



TANDEN MET 3 GESLEPEN KANTEN, DE TANDEN ZIJN ZWAARDER UITGEVOERD EN NIET GEBOGEN.

INNOVATIEVE (ASYMMETRISCHE) TANDGEOMETRIE  
GEOOPTIMALISEERD ONTWERP VOOR HET KNIPPEN VAN DIKKERE TAKKEN

**PROMO**

Gratis accu 4,0Ah na online registratie UH006GM201 of UH007GM201



UH006GM201

	UH006GZ	UH006GM201	UH007GZ	UH007GM201
Uitvoering	Terugsnoei	Terugsnoei	Terugsnoei	Terugsnoei
Snijlengte	60 cm	60 cm	75 cm	75 cm
Max. takdikte	25 mm	25 mm	25 mm	25 mm
Aantal snijbewegingen	2000/3000/4000 min <sup>-1</sup>	2000/3000/4000 min <sup>-1</sup>	2000/3000/4000 min <sup>-1</sup>	2000/3000/4000 min <sup>-1</sup>
Bijgeleverde accu's	0	2x BL4040	0	2x BL4040
Bijgeleverde lader	0	DC40RA	0	DC40RA
Gewicht	4,4 - 5,0 kg	4,4 - 5,0 kg	4,6 - 5,2 kg	4,6 - 5,2 kg
Prijs in €	excl. btw			
	incl. btw			

## UH013GZ / UH013GM101 / UH014GZ / UH014GM101

ACCU HEGGENSCHAREN 40VMAX MET ENKELZIJDIG MES



**PROMO**

Gratis accu 4,0Ah na online registratie UH013GM101 of UH014GM101



UH014GM101

HOGHE SNIJSNELHEID EN HOOG KOPPEL  
LICHT EN GOED UITGEBALANCEERD ONTWERP  
STANDAARD MET OPVANGKAP

\* niet compatibel met BL4080F

	UH013GZ	UH013GM101	UH014GZ	UH014GM101
Snijlengte	60 cm	60 cm	75 cm	75 cm
Max. takdikte	18 mm	18 mm	18 mm	18 mm
Aantal snijbewegingen	2000/3000/5000 min <sup>-1</sup>	2000/3000/5000 min <sup>-1</sup>	2000/3000/5000 min <sup>-1</sup>	2000/3000/5000 min <sup>-1</sup>
Bijgeleverde accu's	0	1x BL4040	0	1x BL4040
Bijgeleverde lader	0	DC40RA	0	DC40RA
Gewicht	3,5 - 4,5 kg	3,5 - 4,5 kg	4,0 - 4,7 kg	4,0 - 4,7 kg
Prijs in €	excl. btw			
	incl. btw			

## DUH483Z / DUH483RFE / DUH523Z / DUH523RFE / DUH551Z

ACCU HEGGENSCHAREN

18V  
LITHIUM-ION

18V → 36V

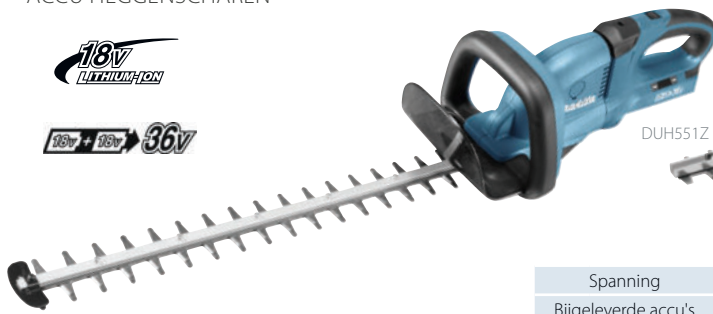

DUH551Z



DUH523RFE

	DUH483Z	DUH523Z	DUH483RFE	DUH523RFE	DUH551Z
Spanning	18 V	18 V	18 V	18 V	2 x 18 V
Bijgeleverde accu's	-	-	2 x accu 3,0 Ah	2 x accu 3,0 Ah	-
Bijgeleverde lader	-	-	DC18RC	DC18RC	-
Snijlengte	48 cm	52 cm	48 cm	52 cm	55 cm
Maximale takdikte	15 mm	15 mm	15 mm	15 mm	18 mm
Gewicht	3,1 kg	3,2 kg	3,1 kg	3,2 kg	4,1 kg
Prijs in €	excl. btw				
	incl. btw				

## DUH502Z / DUH502RT / DUH602Z / DUH602RT / DUH752Z / DUH752RT

ACCU HEGGENSCHAREN 18 V

18V  
LITHIUM-ION  
**BL MOTOR**  
**XPT**  
EXTREME PROTECTION TECHNOLOGY

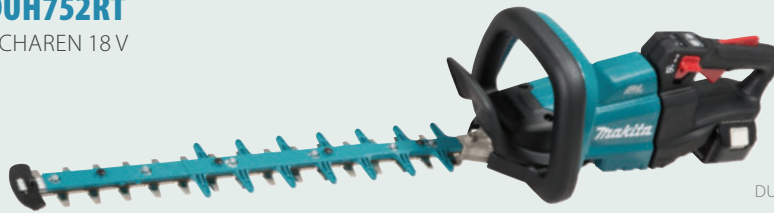

DUH502RT

KLASSIEKE GEOMETRIE

	DUH502Z	DUH502RT	DUH602Z	DUH602RT	DUH752Z	DUH752RT
Bijgeleverde accu's	-	1 x accu 5,0 Ah	-	1 x accu 5,0 Ah	-	1 x accu 5,0 Ah
Lader	-	1 x DC18RC	-	1 x DC18RC	-	1 x DC18RC
Snijlengte	50 cm	50 cm	60 cm	60 cm	75 cm	75 cm
Gewicht	3,8 kg	3,8 kg	3,8 kg	3,8 kg	3,8 kg	3,8 kg
Prijs in €	excl. btw					
	incl. btw					

## DUH501Z / DUH501RTE / DUH601Z / DUH601PTE / DUH751Z / DUH751PTE / DUH754SZ

ACCU HEGGENSCHAREN 18 V

18V  
LITHIUM-ION  
**BL MOTOR**  
**XPT**  
EXTREME PROTECTION TECHNOLOGY

DUH754SZ



DUH601PTE

INNOVATIEVE  
GEOMETRIE

Beter snijresultaat  
Minder wrijving  
Grotere  
batterijautonomie

	DUH501Z	DUH601Z	DUH751Z	DUH501RTE	DUH601PTE	DUH751PTE	DUH754SZ
Bijgeleverde accu's	0	0	0	2 x accu 5,0 Ah	2 x accu 5,0 Ah	2 x accu 5,0 Ah	0
Lader	-	-	-	DC18RC	DC18RD	DC18RD	-
Snijlengte	50 cm	60 cm	75 cm	50 cm	60 cm	75 cm	75 cm
Mes	Dubbelzijdig	Dubbelzijdig	Dubbelzijdig	Dubbelzijdig	Dubbelzijdig	Dubbelzijdig	Enkelzijdig
Gewicht	3,7 kg	3,8 kg	4,0 kg	3,7 kg	3,8 kg	4,0 kg	3,4 kg
Prijs in €	excl. btw						
	incl. btw						

**DLM460PT2 / DLM462Z**

ACCU GRASMAAIERS

**SOFT  
NO LOAD**

DLM462Z

18V + 18V →

36V

**XPT**  
EXTREME PROTECTION TECHNOLOGY**BL**  
MOTOR**PROMO**Gratis accu 6,0Ah na  
online registratie  
DLM462Z

		DLM460PT2	DLM462Z
Spanning		2 x 18 V	2 x 18 V
Max. uitgangsvermogen		1450 W	1600 W
Lader		DC18RD	-
Bijgeleverde accu's		2 x accu 5,0 Ah	-
Max. maaioppervlakte		1600 m <sup>2</sup>	1800 m <sup>2</sup>
Maai breedte		46 cm	46 cm
Chassis		Staal	Staal
Zelftrekkend		-	✓
Inhoud opvangbak		60 l	60 l
Mulching		✓	✓
Gewicht		25,3 kg	36 kg
Prijs in €	excl. btw		
	incl. btw		

**DLM532Z / DLM533Z**

ACCU GRASMAAIERS

**BL**  
MOTOR**XPT**  
EXTREME PROTECTION TECHNOLOGY**SOFT  
NO LOAD****PROMO**Gratis accu 6,0Ah na  
online registratie  
DLM532Z en DLM533Z

18V + 18V → 36V



DLM532Z

**DLM533Z**EXTRA ROBUUST  
ALUMINIUM CHASSIS  
MET STALEN BUMPER  
4 ACCUPOORTEN

DLM533Z

		DLM532Z	DLM533Z
Spanning		2 x 18 V	2 x 18 V
Max. uitgangsvermogen		1600 W	1600 W
Lader		-	-
Maai breedte		53 cm	53 cm
Max. maaioppervlakte		2000 m <sup>2</sup>	2000 m <sup>2</sup>
Chassis		Staal	Aluminium
Inhoud opvangbak		70 l	70 l
Mulching		✓	✓
Zelftrekkend		✓	✓
Gewicht		39,1 kg	42,8 kg
Prijs in €	excl. btw		
	incl. btw		

**LM001JM101 / LM002JM101**

ACCU GRASMAAIERS

**64Vmax****SOFT  
NO LOAD****XPT**  
EXTREME PROTECTION TECHNOLOGY**BL**  
MOTOR

LM002JM101

		LM001JM101	LM002JM101
Accuplatform		64Vmax	64Vmax
Inbegrepen accu's		BL6440 (4,0 Ah)	BL6440 (4,0 Ah)
Inbegrepen lader		DC64WA	DC64WA
Max. uitgangsvermogen		2300 W	2300 W
Maai breedte		48 cm	53,4 cm
Maaihoogte		2 - 10 cm	2 - 10 cm
Capaciteit opvangbak		62 l	70 l
Toerental onbelast		2,500 - 3,200 min <sup>-1</sup>	2,300 - 2,800 min <sup>-1</sup>
Aanbevolen oppervlakte		1,400 m <sup>2</sup>	1,600 m <sup>2</sup>
Zelftrekkend		-	-
Mulching		✓	✓
Gewicht		24,4 - 26,1 kg	25,7 - 27,6 kg
Prijs in €	excl. btw		
	incl. btw		

## UV3200 / UV3600

ELEKTRISCHE VERTICUTEERMACHINES

UV3200



UV3600



	UV3200	UV3600
Vermogen	1300 W	1800 W
Werkbreedte	32 cm	36 cm
Polypropyleen chassis	✓	✓
Gewicht	15 kg	18,3 kg
Prijs in €	excl. btw	
	incl. btw	

## INFO

De "Max. aanbevolen maaiooppervlakte" is de maximum oppervlakte waar de machine qua vermogen, mechaniek en werkbreedte voor geschikt is. Opgelet, dit komt niet noodzakelijk overeen met de autonomie, die afhankelijk is van het type batterijen dat gebruikt wordt en de maaioomstandigheden (de hoogte en dichtheid van het gras, de helling van het terrein enz). Dus het kan voorkomen dat de accu's tussenin bijgeladen moeten worden om de volledige oppervlakte te kunnen maaien.

## DLM330Z / DLM330SM

ACCU GRASMAAIERS

LICHT EN COMPACT  
KAN VERTICAAL GESTOCKEERD  
WORDEN  
IDEAAL VOOR KLEINE OPPERVLAKTES



DLM330SM



	DLM330Z	DLM330SM
Spanning	1 x 18 V	1 x 18 V
Bijgeleverde accu's	-	1 x accu 4,0 Ah
Lader	-	DC18SD
Max. uitgangsvermogen	450 W	450 W
Maaibreedte	33 cm	33 cm
Max. maaiooppervlakte	450 m <sup>2</sup>	450 m <sup>2</sup>
Chassis	Polypropyleen	Polypropyleen
Inhoud opvangbak	30 l	30 l
Mulching	✓	✓
Gewicht	11,6 - 12,5 kg	11,6 - 12,5 kg
Prijs in €	excl. btw	
	incl. btw	

## DLM480CT2 / DLM481CT2 / DLM539CT2

ACCU GRASMAAIERS



DLM481CT2



DLM539CT2

	DLM480CT2	DLM481CT2	DLM539CT2
Spanning	2 x 18 V	2 x 18 V	2 x 18 V
Bijgeleverde accu's	2 x accu 5,0 Ah	2 x accu 5,0 Ah	2 x accu 5,0 Ah
Max. uitgangsvermogen	860 W	860 W	860 W
Lader	DC18SH	DC18SH	DC18SH
Maaibreedte	48 cm	48 cm	53,4 cm
Max. maaiooppervlakte	800 m <sup>2</sup>	800 m <sup>2</sup>	1000 m <sup>2</sup>
Chassis	Polypropyleen	Polypropyleen	Polypropyleen
Zelftrekkend	-	✓	✓
Inhoud opvangbak	62 l	62 l	70 l
Mulching	✓	✓	✓
Gewicht	24,5 - 26,8 kg	27,1 - 29,3 kg	28,0 - 30,5 kg
Prijs in €	excl. btw		
	incl. btw		